

ECON D4

sauna control unit

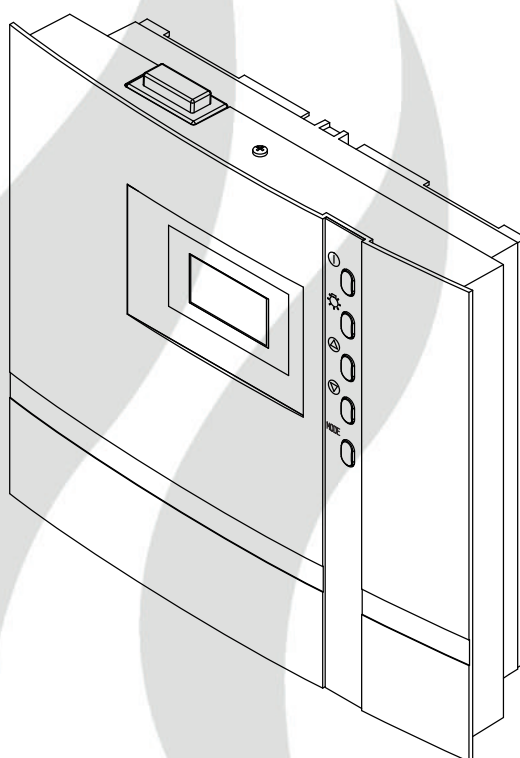

GB Assembly and operation instruction

Made in Germany

CE IP x4



English

content

Scope of Delivery	4
Technical data.....	5
General information about using the sauna.....	6
General safety information	7
Assembly of the control unit.....	9
Assembly on the wall.....	9
Assembly in the wall	10
Connection of the sensor lines.....	11
Assembly of the stove sensor	11
Installing the optional bench sensor	13
Electrical connection	14
Connecting the sauna heater	14
Connection of a load switching unit (LSG)	14
Connecting the vaporizer	14
Connecting the sauna lamp.....	14
Connecting a fan	14
Installation diagram	15
Terminal arrangement on the circuit board.	15
Wiring diagram sauna heater up to 9 kW.....	16
Wiring diagram sauna heater > 9 kW.....	16
Operation	17
General.....	17
The user interface	17
Control buttons	17
Basic stand by screen.....	18
Basic operating screen	18
Energy-saving screen.....	18
Cabin lighting.....	19
Fans	20
Initial commissioning	21
Changing the language.....	22
Changing the time.....	22
Activating the Life-Guard.....	23
Activation/deactivation of the child lock.....	23
Activation of the sauna stove	24
Deactivation of the sauna stove in Finnish mode	24

Activation of the sauna stove with Life-Guard	24
Individual settings	25
Cabin temperature	25
Auto-stop	26
Preselection time	28
Activation of the preselection time	29
Deactivation of the preselection time	29
Life-Guard	30
Extend heat-up time restriction	31
Replace device fuse	31
Error messages	32
The device switch (switch-off)	33
Manual specification of the lighting	34
Holiday home mode	35
Recycling	36
Service address	36
Guarantee	36
Handling procedures for return shipments (RMA) - Details for all returns !	37

Standard delivery

(Subject to change)

Included in control unit scope of delivery:

1. Stove sensor board with over-temperature fuse, PTC sensor with sensor housing, two attachment screws 3 x 25 mm and sensor cable approx. 2.0 m long.
2. Plastic bag containing three mounting screws 4 x 20 mm.
3. Spare over-temperature protection

Technical data

- Rated voltage: 400 V 3 N 50 Hz AC
- Switch output: max. 9 kW resistive load (AC1 mode). Can be expanded to 36 kW via the connection of power switching devices
- Heat-up time restriction: 6 h, 12 h / without heat-up time restriction
- Display: LCD display 65 x 37 mm, graphic
- Dimensions (HxWxD): 220 x 250 x 67 mm
- Protection class: IPx4 acc. to EN 60529 splashwater protection
- Control range in the sauna mode: 30 to 115°C
- Sensor system (temperature): PTC sensor with safety temperature limiter 142°C
- Control characteristic: Two-point control with fixed hysteresis of 3K. For control via the stove sensor offset of 7K to compensate the higher temperatures directly below the cabin ceiling
- Fan output: max. 100 W, no capacitor motors, controlled via phase control
- Light: max. 100 W (automatic switching phase control / phase cut-off)
- Ambient temperatures: -10°C to +40°C
- Storage temperature: -20°C to +70°C
- Temperature display stove sensor: Current value on the stove sensor minus 7K to compensate the higher temperatures directly below the cabin ceiling
- Temperature display bench sensor: Current value on the bench sensor

Dear customer

You have purchased a high-quality technical device with which you will have years of sauna fun. This sauna control unit was designed and inspected according to the current European safety standards and manufactured at the factory in accordance with the quality management standard DIN EN ISO 9001:2000.

This detailed installation and operation manual has been prepared for your information. Please observe in particular the **important notes** and the information on electrical connection.

We wish you exhilarating recreational experience and lots of fun with your sauna!

Intended use

This sauna control unit is exclusively intended for the control of the sauna heater in a sauna cabin.

Any other use over and above the intended purpose is not considered as appropriate use! Compliance of the standard operation, maintenance and repair conditions is also an element of appropriate use.

The manufacturer cannot be held liable for deviating, unauthorized alterations and any resulting damages: the initiator of these changes bears the full risk.

General information

Please check whether the unit has arrived in perfect condition. Any transport damages should be immediately reported to the freight forwarder delivering the goods or you should contact the company that shipped the goods.

Please note that you will only be able to achieve an optimum sauna climate if the cabin with its air intake and ventilation, the sauna heater and the control unit are aligned to each other.



Please observe the information and stipulations made by your sauna supplier.

Sauna heaters heat up your sauna cabin using heated convective air. Here, fresh air is drawn in from the air intake which, when heated, rises upwards (convection) and is then circulated within the cabin. Part of the used air is pushed out through the vent in the cabin. This creates a typical sauna climate which can achieve temperatures of approx. 110°C measured directly under the ceiling of your sauna, dropping in temperature to approx. 30-40°C towards the floor. It is therefore not unusual to measure temperatures of 110°C on the temperature sensor hanging over the heater, whilst the thermometer hanging on the sauna wall, approx. 20-25 cm under the cabin ceiling, only indicates 85°C. The bathing temperature generally lies between 80°C and 90°C in the area of the upper bench when the temperature is set to maximum.

Please note that the highest temperatures are always generated over the sauna heater and that the temperature sensor and the safety limiter must be mounted there in accordance with the control unit installation instructions.

When heating up for the first time, you may notice a slight smell caused by evaporating lubricants used in production processes. Please ventilate your cabin before beginning your sauna bath.

General safety precautions

- This device can be used by children aged 8 upwards and by persons with physical, sensory, or mental disabilities, or who have inadequate experience and knowledge if they are supervised or if they have received adequate instruction in how to use the device safely and understand the associated risks. Children may not play with this device. Children may not clean or carry out any user maintenance if unsupervised.
- Children are to be supervised in order to make sure that they do not play with this device.
-  **Attention:** It is forbidden to install the control box in a closed switch cabinet or behind a wooden panelling!
- The electrical installation may be done only by a qualified electrical technician.
- You must comply with the regulations of your power supply company and applicable VDE regulations (DIN VDE 0100).
-  **WARNING:** Never attempt repairs or installations yourself, as this could result in serious injury or death. Only a qualified technician may remove the housing cover.
- Please note the dimensions in the assembly instructions, especially when installing the temperature sensor. The temperature above the oven is critical for the temperature setting. The temperature can be held within operating parameters and a minimal temperature gradient inside the bench area of the sauna cabin can be achieved only if unit is assembled correctly.
- The device may only be used as intended as a control unit for sauna ovens up to 9 kW (up to 36 kW when combined with a contactor box).
- Completely disconnect the control unit from the electrical circuit, i.e. flip all circuit breakers or the main circuit breaker during each installation or repair.
- Please note the safety and installation information from the sauna oven manufacturer.
- Always heed the specifications and instructions of the cabin manufacturer, too.



Attention!

When using control units that offer the possibility of external access (GSM-module, remote button, etc.) or time-delayed switching (preselection time, weekly timer, or similar) a protective system for the sauna heater is required (cover protection type 1-6 or S-Guard).



Attention!

Dear customer,
according to the valid regulations, the electrical connection of the sauna heater and the control box has to be carried out through the specialist of an authorized electric shop

We would like to draw your attention that in case of a warranty claim, you are kindly requested to present a copy of the invoice of the executive electric shop.

Installation of the control unit

Wall installation

The control unit may only be mounted outside the sauna cabin. It is advisable to select the outside wall of the cabin to which the sauna heater is fixed from the inside as mounting position. If ductwork is already provided for electrical installations then the position of the control unit is predetermined by that. Please follow the instructions for installation:

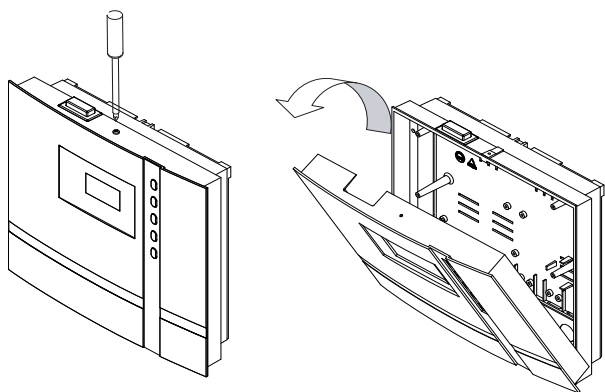

Fig. 1

Remove the control device cover. In order to do this loosen the screw at the top of the housing and pull the housing top upward while swivelling (Fig. 1).

Surface-mounted installation

1. The 3 mm diameter boreholes for the supplied wood screws 4 x 20 mm are drilled according to the dimensions shown in Fig. 3 + 3.1.
2. Insert one of the wood screws into the top center hole. The control unit is hooked onto this screw. Therefore, leave the screw out by approx. 3 mm (Fig. 3.2).
3. Hook the control unit onto the 3 mm protruding screw in the upper mounting hole. Insert the supplied rubber grommets into the openings at the rear wall of the housing and insert the connecting cable through these openings.

Fasten the housing bottom at the two bottom openings (Fig. 4) firmly to the cabin wall.

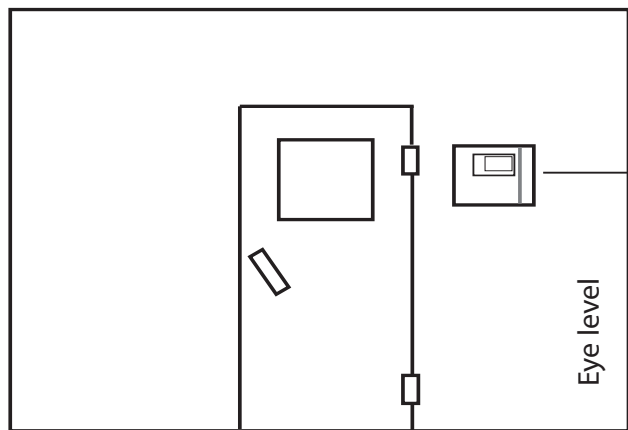

Fig. 3

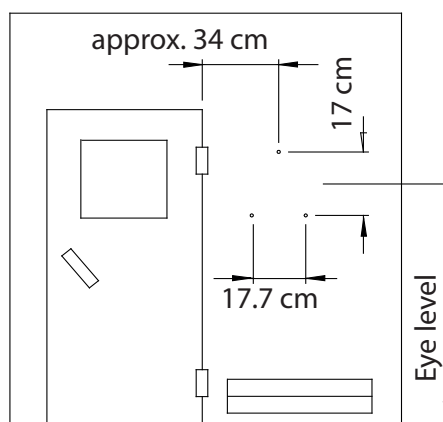

Fig. 3.1

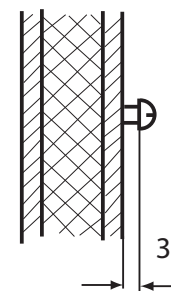

Fig. 3.2

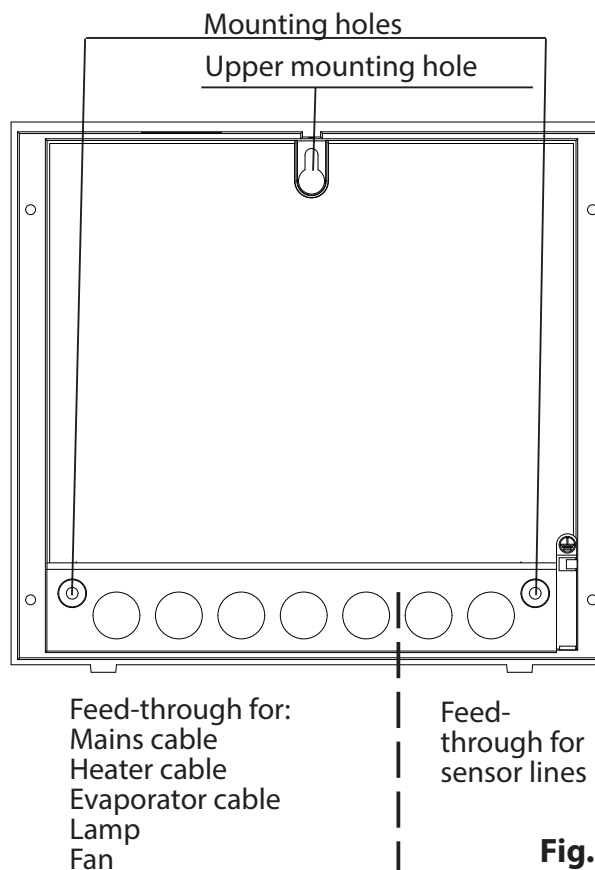

Fig. 4

Recessed installation

1. Cut out a wall section that is at least 3.5 cm deep according to the dimension in Fig. 5.

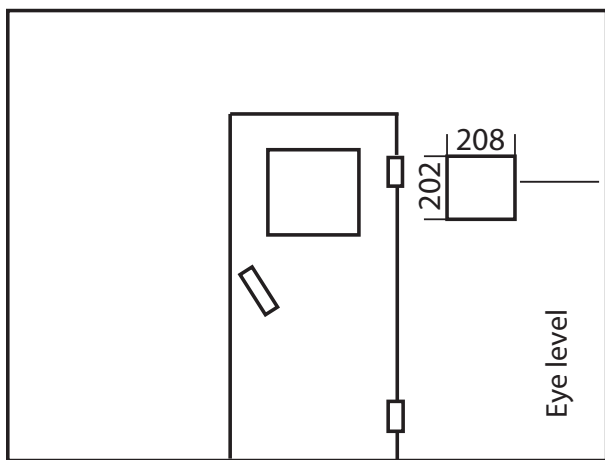

Fig. 5

Insert the supplied rubber grommets into the openings at the rear wall of the housing and insert the connecting cables through these openings.

Place the control unit into the wall opening and fasten it with 4 wood screws.

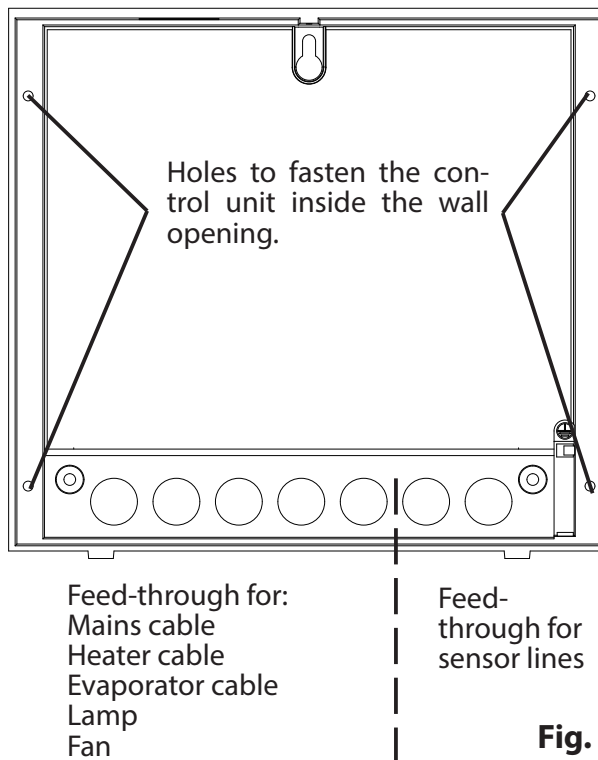

Fig. 6

Connecting the sensor cables

You should not install sensor and power supply lines together, or lead them through the same feedthrough. This can lead to interferences in the electronics, such as "fluttering" in the relays. If it is necessary to lay the cables down together, or if the line is longer than 3m, use a shielded sensor cable (4 x 0.5 mm²).

Connect the shielding to ground in the control unit.

Please note that the following dimensional information refers to values defined by the device test in compliance with EN 60335-2-53. The stove sensor always needs to be mounted at the place where the highest temperatures are expected. Fig. 7 - 9 provide an overview of the sensor assembly position, unless the position is defined in the user manual for the stove.



Installation of the heater sensor

1. The stove sensor is mounted in cabins up to 2 x 2 m in size as shown in Fig. 7 and 8; in larger cabins it is mounted as shown in Fig. 7 and 9.

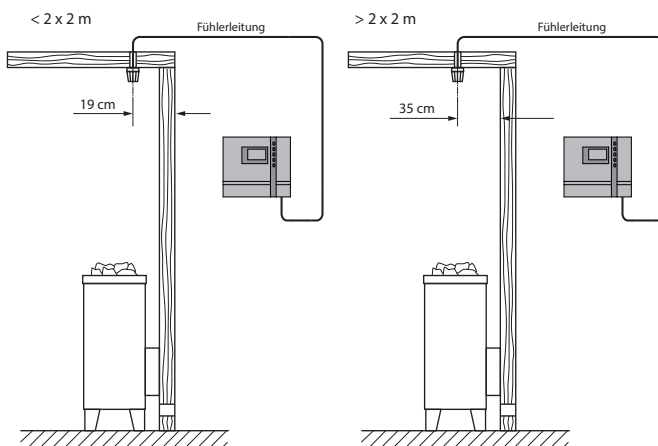

Figure 7

Figure 8

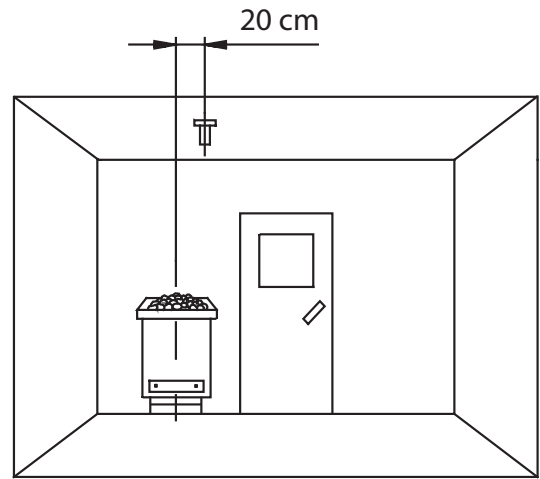

Figure 9

2. Drill a hole for the cable opening, preferably in the middle of a profiled plank.
3. Feed the sensor cable through the drilled hole and then connect the sensor line as shown in Fig. 10.
4. The lines for the limiter (white) and connect the temperature sensor (red) according to Fig. 10 to the sensor board: Then click the sensor board into position in the housing.
5. Guide the sensor lines to the control unit and feed them into the device through the right-hand cable opening. Install the sensor lines within the control unit as shown in Fig. 11. Connect the sensor lines as shown in Fig. 12. To this end, the plug **X2** is disconnected from the board and then reinserted after the connection.
6. After mounting and the correct operation of the control unit, the line to the over-

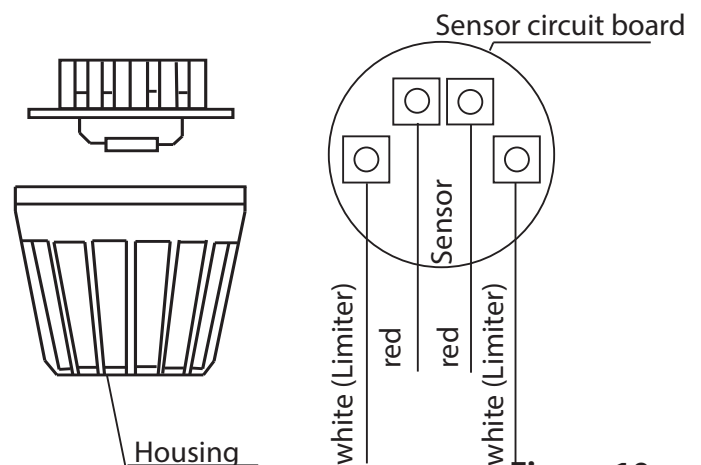

Figure 10

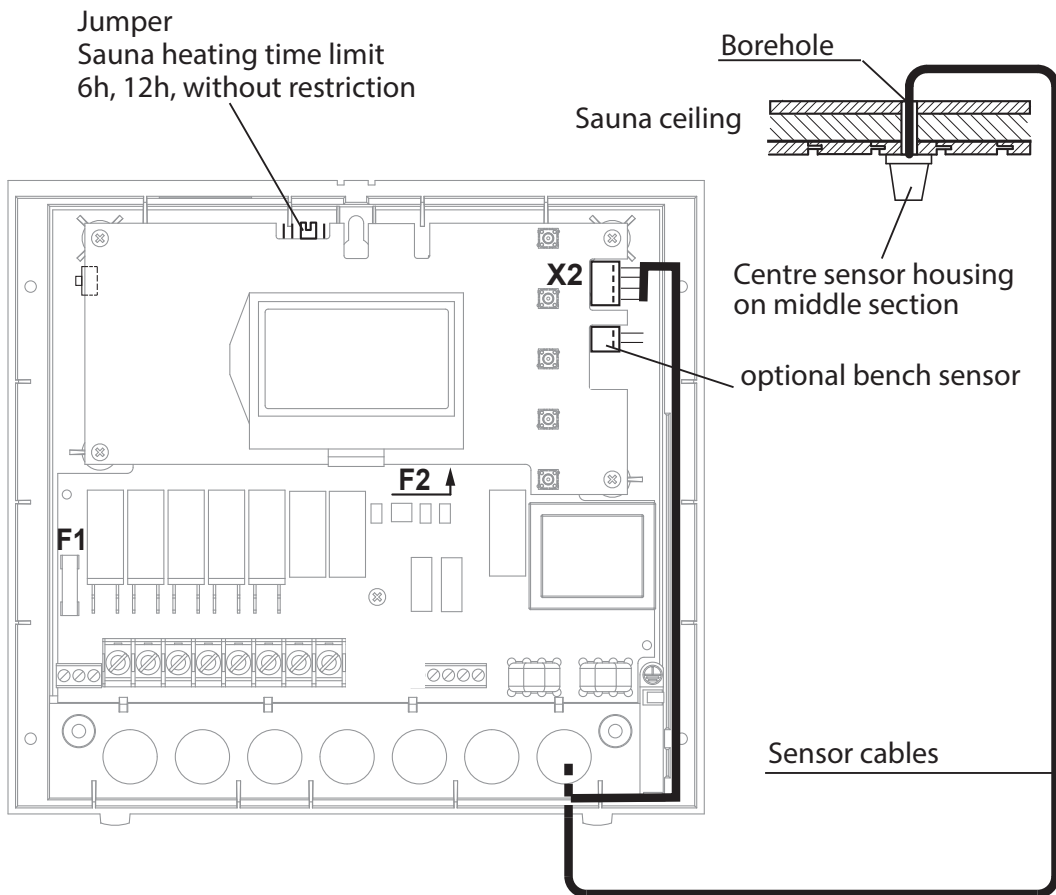

Figure 11

Caution! If the lines on plug X2 are confused, this can trigger F2 and damage the unit (Replacement, see paragraph "Replace device fuse")

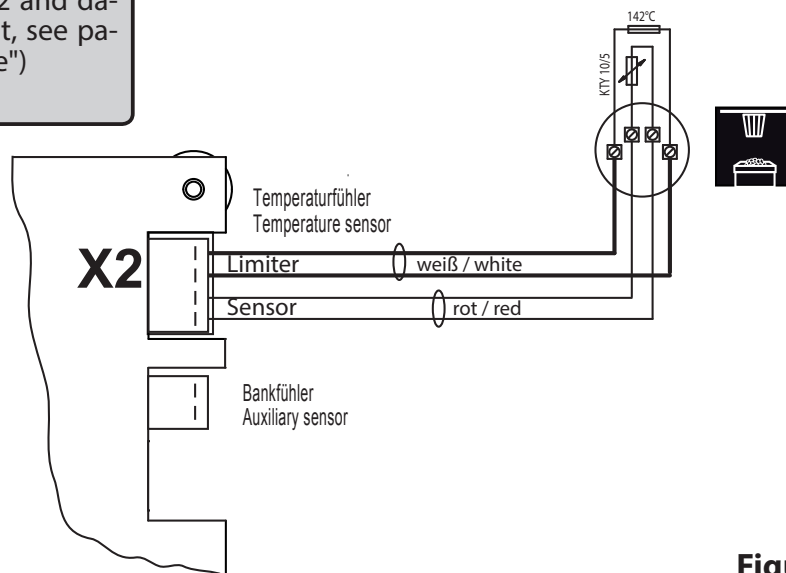
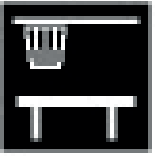

Figure 12

temperature fuse must be checked for short circuits. To do this, release one of the white lines in the sensor housing. The respective error message appears in the display.





Installing the optional bench sensor 13

Assembly site: The bench sensor (2nd temperature sensor) is attached to the ceiling above the rear bench opposite the stove, as described in the instructions for the assembly of the stove sensor.

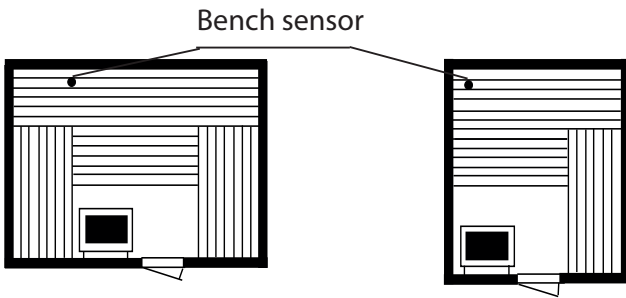

The bench sensor is connected to the control unit via a 2-wire silicon line on the terminal on the right-hand side of the board (see figure).

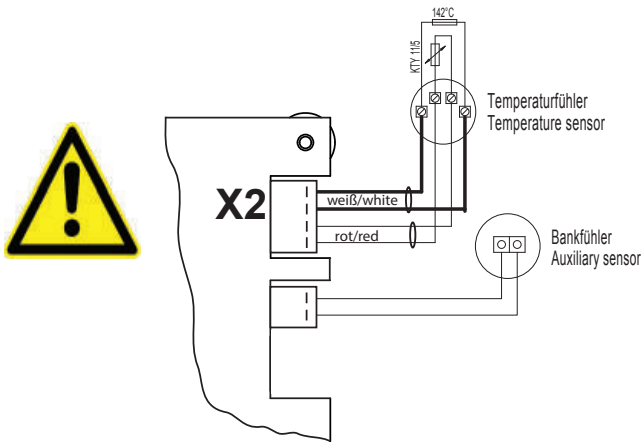

When the sensor is connected correctly, the control unit recognises the sensor automatically after the mains supply has been switched on again.

The following error message appears if there is a bench sensor malfunction:

"Broken bench sensor" - interruption of the connection in or to the sensor

or

"Short circuit bench sensor" - short circuit of the sensor

In this case, arrange for a specialist to check or possibly replace the sensor. The sensor has a resistance of approx 1.9 kW at 20 °C.

To be able to continue using your sauna even though the bench sensor is faulty, the bench sensor can be deactivated by disconnecting the connection and the device receives power again from the mains supply after being shut down.

Once the malfunction has been rectified, the control unit recognises the sensor again after the mains supply has been switched on again.

Electrical connection

The electrical connection may only be done by a certified electrician in compliance with the guidelines of the local utility company and the VDE.

In general, there may be only one fixed connection to the network; therefore equipment should be provided that makes it possible to disconnect the system with all poles from the network with a contact opening width of minimum 3 mm.

All electrical installations and all connection lines that are installed inside the cabin must be suitable for an ambient temperature of at least 170 °C.

The power supply line is run to the control unit and connected to the power input terminals.



Connecting the sauna heater

Install the sauna heater and the vaporizer in front of the air intake according to the manufacturer's installation instructions.

Run the silicone line through the ductwork to the power unit and connect it to the appropriate terminals as directed in the wiring diagram.

Note: If there are no empty tubes, drill a hole next to the vent inlet opening and feed the stove supply line(s) to the outside through this hole to the respective terminals on the control unit. The silicon line needs to be hidden to protect it from external influences. Therefore use a suitable cable duct or a PVC tube to guide the line to the load unit.



Connecting a load switch (LSG)

For more details, please refer to the assembly instructions of the power switching device (LSG).

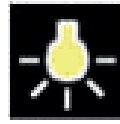

Connecting the sauna lamp

Only use dimmable lighting and ballasts, because otherwise the lights or the control unit may become damaged.

The type of light is recognised automatically, but it can also be defined manually. (See paragraph "Manual definition of the lighting") The sauna light must correspond to the splashwater protection class (IPx4) and must be resistant to the ambient temperature. The sauna light can be mounted anywhere, however never close to the rising flow of hot air from the stove.

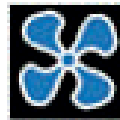

Connecting a fan

Only use fans whose speed can be controlled via phase control. The fan must have the splashwater protection class (IPx4) and must be resistant to the ambient temperature. The fan can be mounted anywhere, however never close to the rising flow of hot air from the stove and must be positioned as far away as possible from the IR spot (it may not be in the light path of the spot).

Assembly of a remote start module

Then insert the sauna bus cable enclosed with the remote start module into the designated sauna bus connection. The other end is inserted into the respective socket in the remote start module. Now mount the remote start module as shown in the enclosed instructions.

Installation diagram

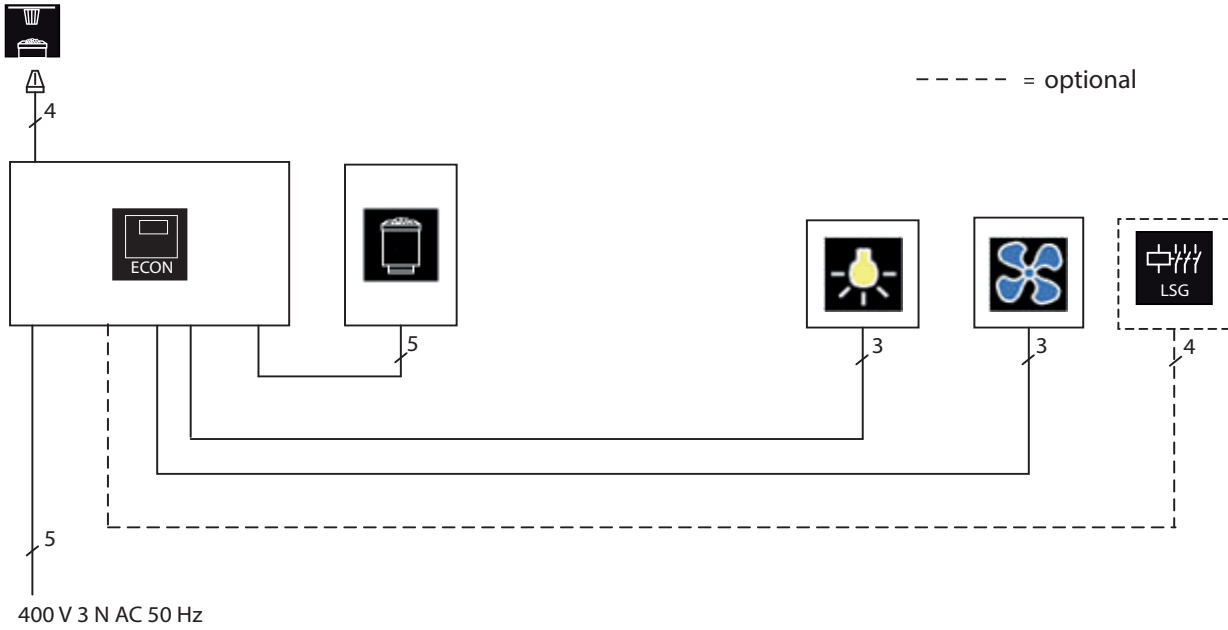

The control lamp for public systems without heat-up time restriction must be installed in the supervisor's room.

Terminal arrangement on the circuit board

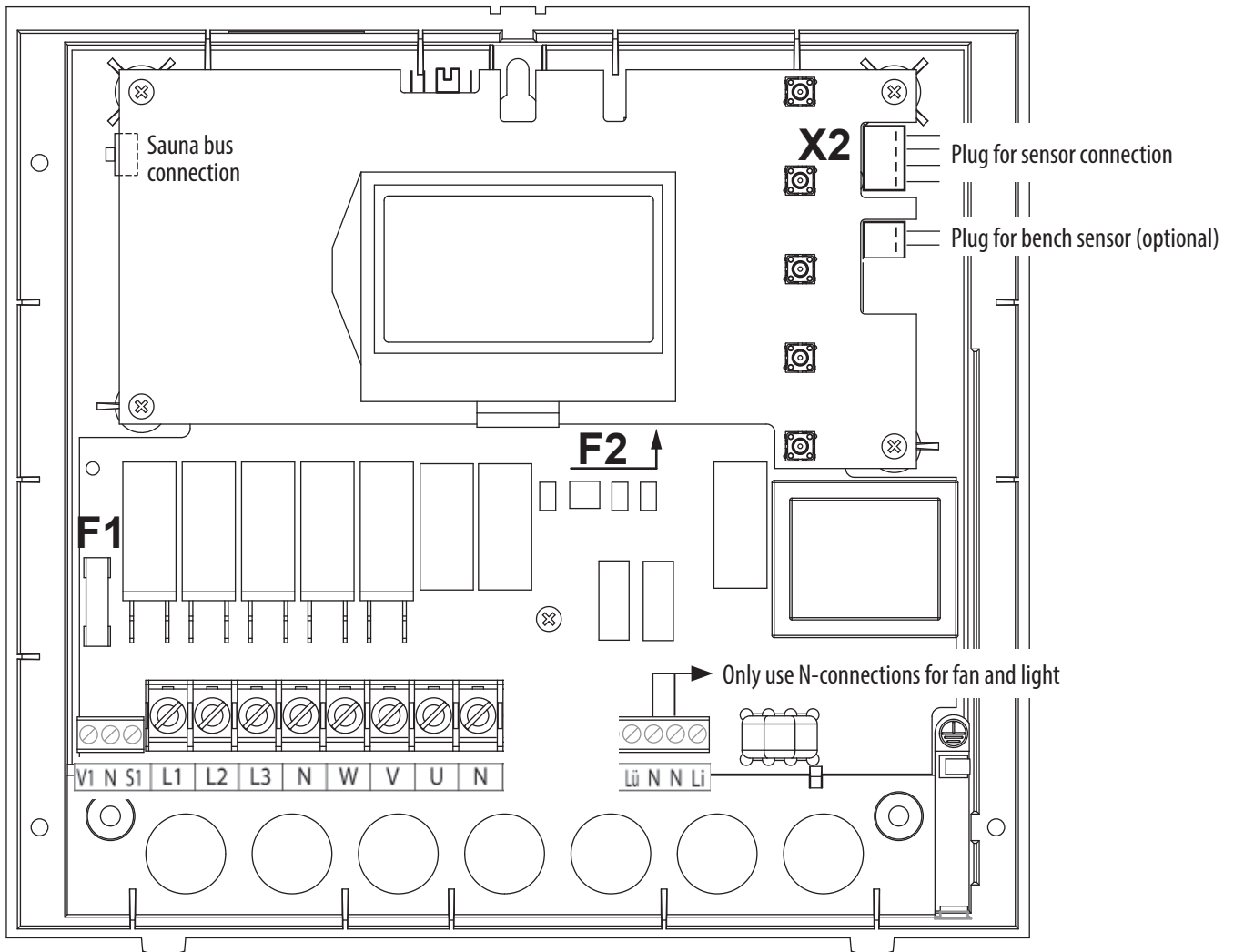

Connecting the sauna heater (max. 9 kW)

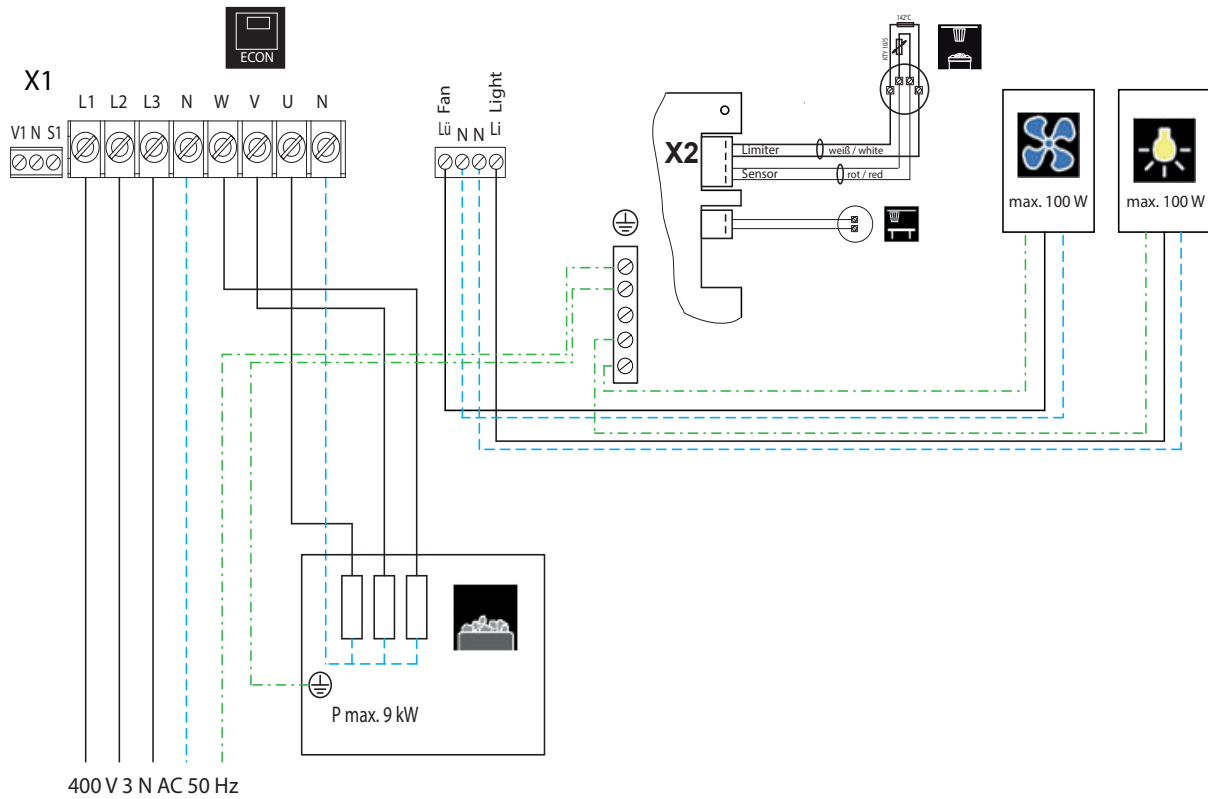

⚠ Caution: Always connect the neutral conductor (N) of the sauna stove. In humidity mode, one phase of the sauna stove is deactivated, i.e. the heating load is not symmetrical. The result is that the neutral conductor is then no longer currentless.

Connecting the sauna heater > 9 kW

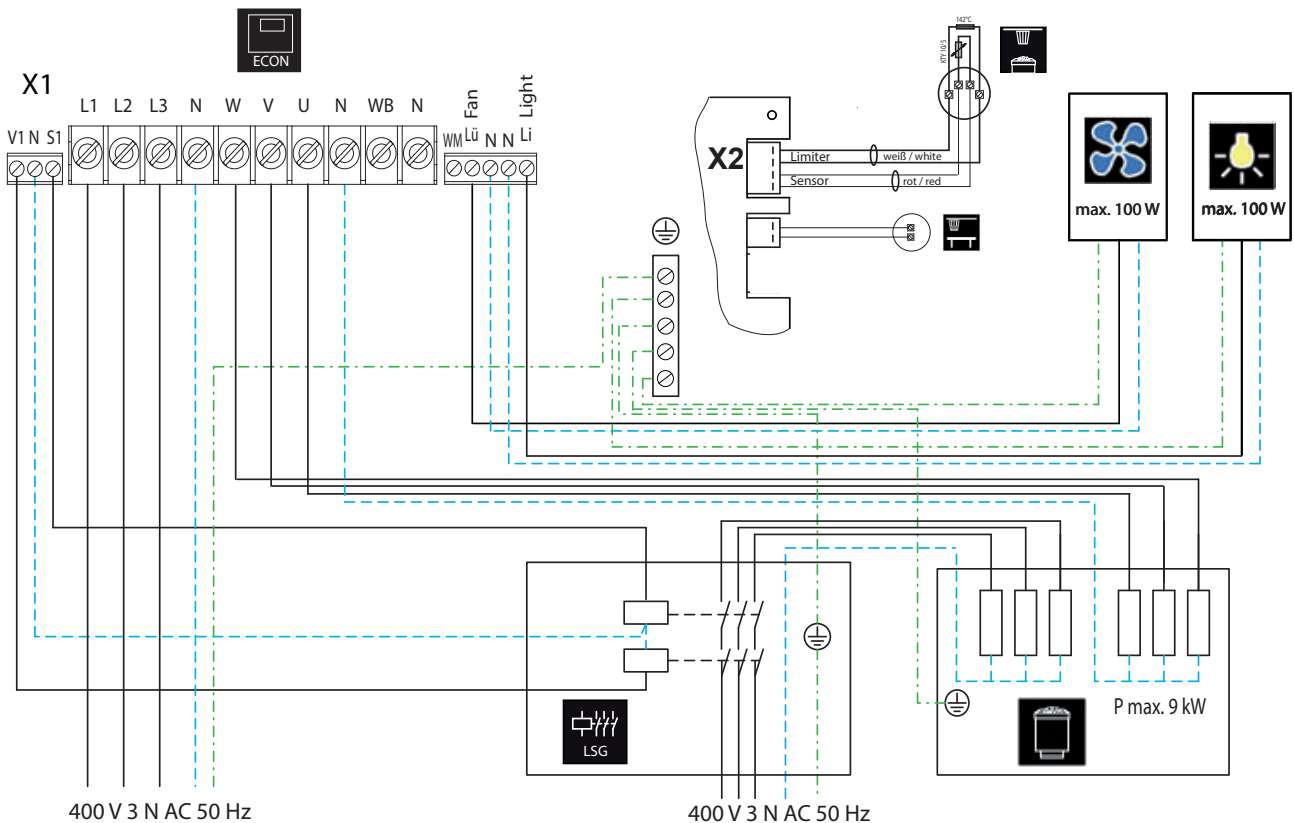

Operation

Once the system has been installed with all components and all covers have been fixed, you can put your sauna unit into operation.

Over the following pages we will show you the options provided to you with the control.

Generalities

The user interface

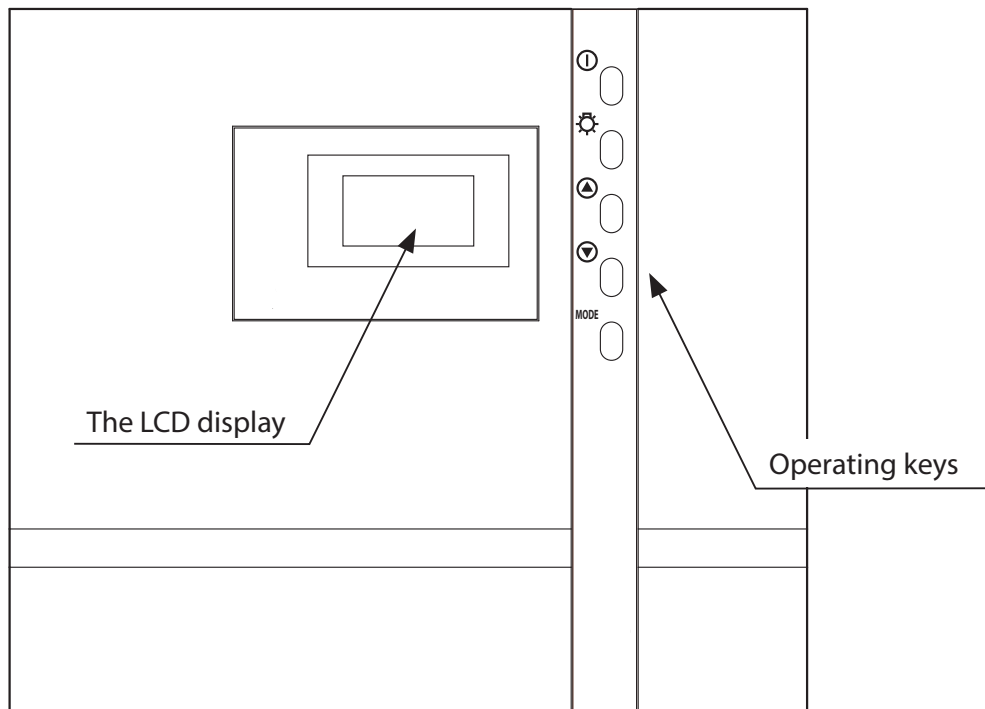

Operating keys

 = Heating on / off (stand-by)

 = Cabin lighting

 = raise value / next function

 = lower value / next function

MODE = Programming mode

Default display Stand-by

is shown if the system is in Stand-by mode.

The system also returns to this screen from other menu items, if there is no activity for >15 seconds.

	🕒 12:00
Temperatur	30°C
Auto-Stop	5 : 59
Vorwahlzeit	-- : --

Default display in operation

is displayed if the system is operational. The system also returns to this screen from other menu items, if there is no activity for >15 seconds.

☀️	🕒 12:15
Temperatur	30°C 📊
Auto-Stop	5 : 59
Vorwahlzeit	-- : --

Illustration of the heating performance:

During the heating phase the bars behind the temperature display fill continuously.

Once the target temperature has been reached, these bars are displayed as filled.



Energy-saving display

If the unit is not used, it will switch into energy-saving mode.

A moving time is shown after 5 minutes, similar to a PC screensaver. The back light for the display is switched off after an additional 15 minutes.

You can return to the basic standby screen by pressing any button.

The following applies for all settings:

The following is shown in the top area of the display:

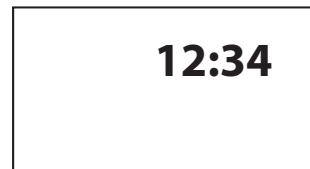

The light symbol
(is the light is switched on)



The clock symbol

12 : 00

Current time

Rolling doors

Remote start module recognised
(flashes if contact to the module has been interrupted in the meantime)



Residual heat phase
(after damp operation)



Child lock active



Preselection time

To adapt the individual values to the respective requirements, the **MODE** button must be pressed briefly from the standby screen.

Those parameters that can be changed are shown in black and the required parameters can be selected with the ▲ or ▼ buttons.

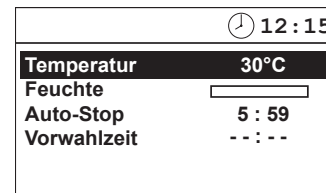

Parameters that blink on the display can be changed and are shown in these instructions as displayed.



You can reach the parameter level by pressing the **MODE** button.

The name of the parameter is now blinking and the modifiable value is highlighted in black.

The value shown in black can be changed via the ▲ or ▼ button.

All settings made from the standby mode are confirmed by pressing **MODE** for >3 secs and are saved in the device.

The parameter stops flashing and the new value is valid until it is changed again.

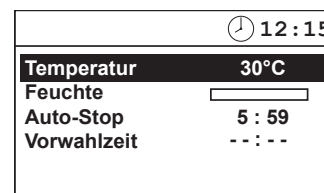
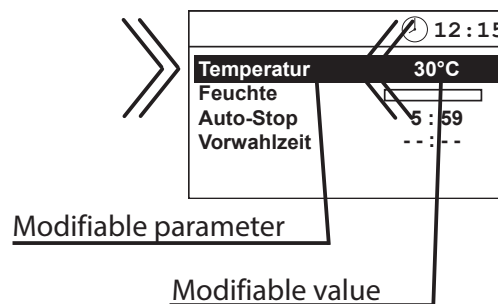

If no button is pressed for >15 secs, the device returns to the basic screen. Any changes made will not be saved



Cabin lighting

Every time that the sauna system is activated, the cabin lighting is automatically switched on. The ☀ symbol is shown at the top left of the display. If the sauna system is switched off, the cabin lighting is also switched off after a delay of 30 minutes.

Regardless of the operational state of the sauna system, the cabin lighting can be switched on or off at any time via the ☀ button.

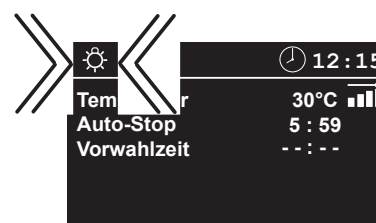

The cabin lighting can be dimmed and saves this value separately for operation mode and standby mode. To change the value for the standby, press the light button in standby for >3s until the light symbol appears with a bar in the display. Now press the HIGH or DOWN buttons repeatedly to set the value. Press the button MODE for >3s to save the value. To set the lighting when the sauna is operational, proceed in the same way even though the sauna is activated (display has a black background). Note: For reasons of safety, the brightness can only be reduced to 25% in standby mode if this is lower than the brightness in operation mode!

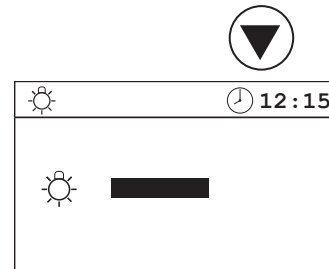
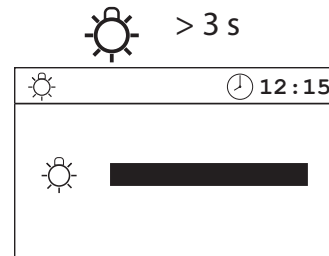

MODE > 3 s

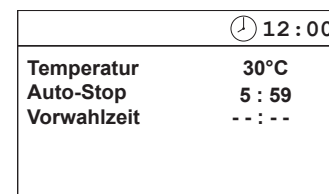

MODE &

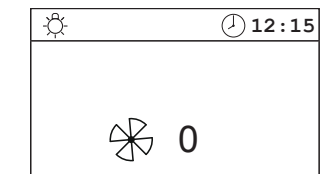

MODE

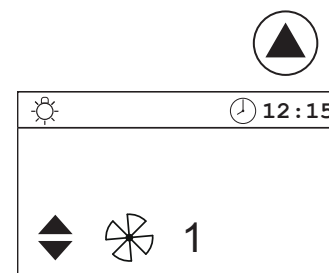
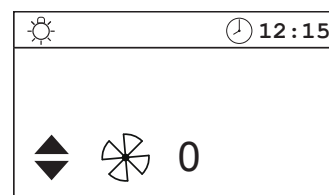

MODE > 3 s



There are four level settings for the fan in operation mode, level 0 corresponds to deactivation of the fan in operation mode. This value is entered when the system is commissioned for the first time, however it can be changed at a later time (see right). In the residual heat phase, a connected fan is always operated at full power.

Initial commissioning

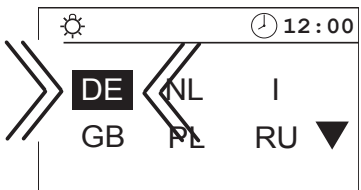
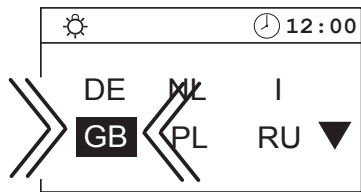

MODE > 3 s



MODE



MODE > 3 s

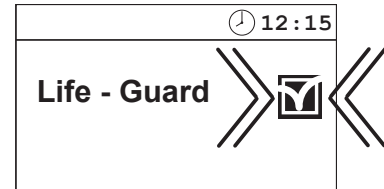
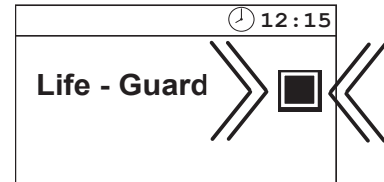

MODE > 3 s

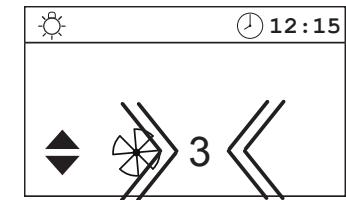
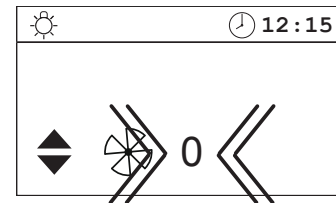

MODE > 3 s

	🕒 12:00
Temperatur	30°C
Auto-Stop	5 : 59
Vorwahlzeit	- : -
Life - Guard	20 min

Change language

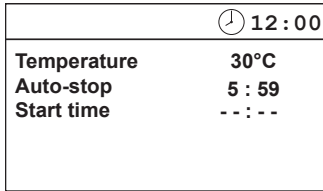

MODE &



/

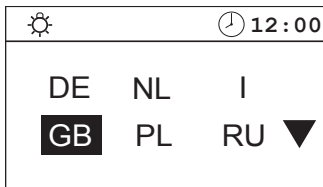

MODE



/

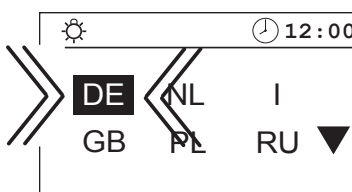

MODE > 3 s



Change time

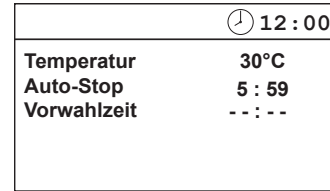

MODE &



MODE



/



MODE



/



MODE > 3 s

Activating the Life - Guard

Life-Guard is a definable, relative short time e.g. 20 min., after which the sauna system is switched off apart from the cabin lights. After this time, the systems can be activated again for the set time by pressing the **MODE** button.

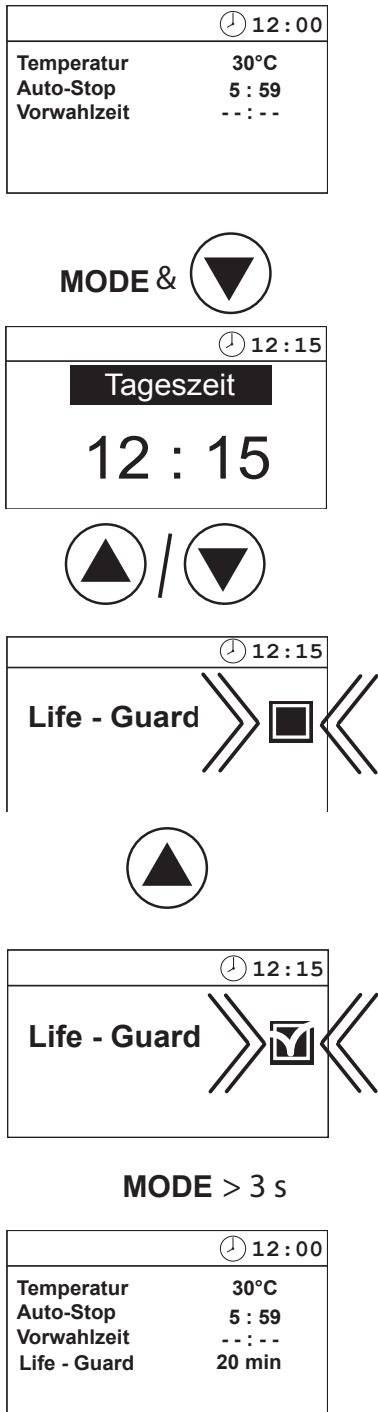

Activate / deactivate the child lock

If the child lock is activated (the key symbol is visible in the upper part of the display), only the cabin lights can be switched. All other buttons have no function. The child lock can be activated / deactivated both in standby and also operation mode. The system can be switched off in operation mode.

Activate

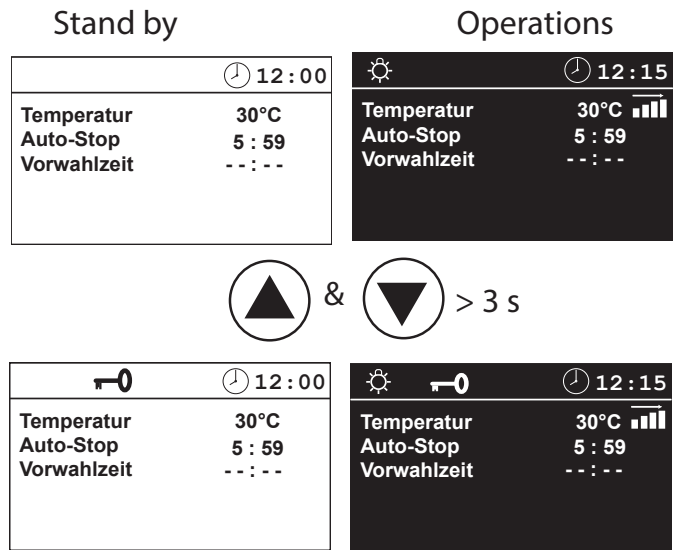

Deactivate

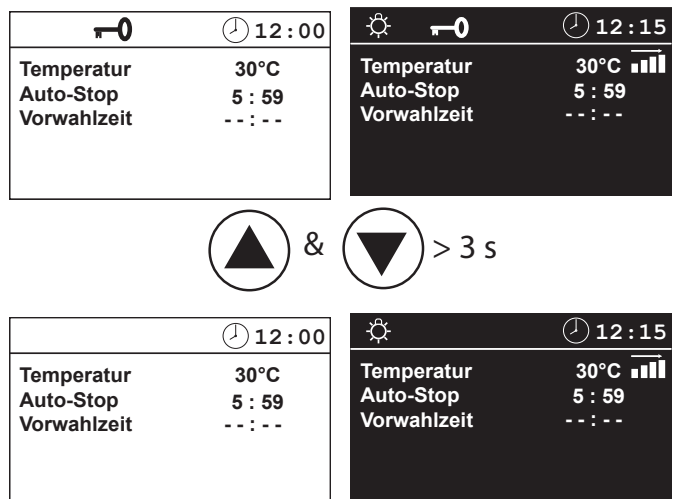

Switching on the sauna unit

🕒 12:00	
Temperatur	30°C
Auto-Stop	5 : 59
Vorwahlzeit	--:--

🔌 > 3 s

🕒 12:15	
☀️	
Temperatur	30°C 📶
Auto-Stop	5 : 59
Vorwahlzeit	--:--

Activation of the sauna system with Life-Guard

🕒 12:00	
Temperatur	30°C
Auto-Stop	5 : 59
Vorwahlzeit	--:--
Life - Guard	20 min

🔌 > 3 s

🕒 12:15	
☀️	
Temperatur	30°C 📶
Auto-Stop	5 : 59
Vorwahlzeit	--:--
Life - Guard	20 min

The sauna stove heats up normally, without Life-Guard time. For activation of the function Life-Guard.

MODE

🕒 12:15	
☀️	
Temperatur	30°C 📶
Auto-Stop	5 : 59
Vorwahlzeit	--:--
Life - Guard	20 min

Deactivation of the sauna system in Finnish mode 2

🕒 12:15	
☀️	
Temperatur	30°C 📶
Auto-Stop	5 : 59
Vorwahlzeit	--:--

Auto-Stop-Time / 🔌

🕒 12:00	
☀️	
Temperatur	30°C
Auto-Stop	5 : 59
Vorwahlzeit	--:--

After expiration of the "Life - Guard" - time the sauna heater is switched off and the entire display blinks.

>>>

🕒 12:15	
☀️	
Temperatur	30°C 📶
Auto-Stop	5 : 59
Vorwahlzeit	--:--
Life - Guard	20 min

<<<

Restart

MODE

🕒 12:00	
Temperatur	30°C
Auto-Stop	5 : 59
Vorwahlzeit	--:--
Life - Guard	20 min

or switch off the system

🔌

🕒 12:00	
Temperatur	30°C
Auto-Stop	5 : 59
Vorwahlzeit	--:--
Life - Guard	20 min

Note:

In the Life-Guard mode, no changes can be made to the temperature or humidity if the device is operational (active heating).

Individual Settings

The following are options for adapting the control systems to your individual needs. The various parameters can be changed in standby or in operation mode and the changes are saved in the device. Changes made in operation mode are implemented immediately.

Cabin temperature Setting range: Finnish mode 30 - 115°C

In Stand-by

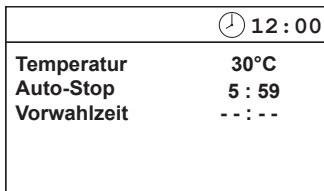

MODE

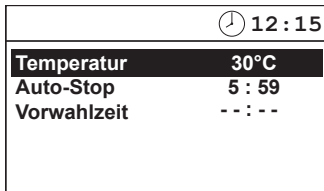

MODE

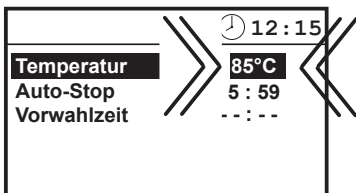
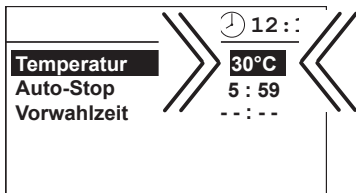

MODE > 3 s

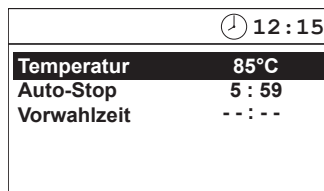

15 s / 🔌 > 3 s

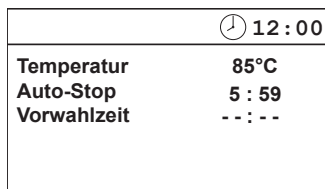

In operation



MODE



MODE

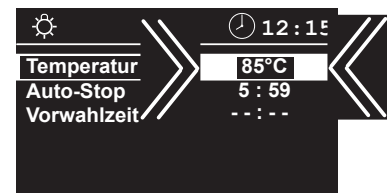
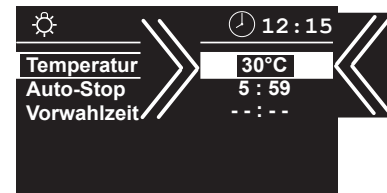

MODE > 3 s



15 s



Auto-stop / heat-up time restriction

Auto-Stop is the time to which the heating time is limited. The sauna unit automatically turns off once this time has expired.

Depending on the configuration of the control unit, a time between 0:01 and 6:00 or 12:00 hours can be set (see page 31).

In Stand-by

🕒 12:00	
Temperatur	30°C
Auto-Stop	5:59
Vorwahlzeit	---:--

MODE

🕒 12:15	
Temperatur	30°C
Auto-Stop	5:59
Vorwahlzeit	---:--



🕒 12:15	
Temperatur	30°C
Auto-Stop	5:59
Vorwahlzeit	---:--

MODE

🕒 12:15	
Temperatur	30°C
Auto-Stop	5:59
Vorwahlzeit	---:--



🕒 12:15	
Temperatur	30°C
Auto-Stop	3:59
Vorwahlzeit	---:--

MODE

🕒 12:15	
Temperatur	30°C
Auto-Stop	3:59
Vorwahlzeit	---:--



In operation

🕒 12:15	
Temperatur	30°C
Auto-Stop	5:59
Vorwahlzeit	---:--

MODE

🕒 12:15	
Temperatur	30°C
Auto-Stop	5:59
Vorwahlzeit	---:--



🕒 12:15	
Temperatur	30°C
Auto-Stop	5:59
Vorwahlzeit	---:--

MODE

🕒 12:15	
Temperatur	30°C
Auto-Stop	5:59
Vorwahlzeit	---:--



🕒 12:15	
Temperatur	30°C
Auto-Stop	3:59
Vorwahlzeit	---:--

MODE

🕒 12:15	
Temperatur	30°C
Auto-Stop	3:59
Vorwahlzeit	---:--



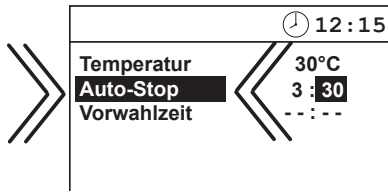

MODE > 3 s

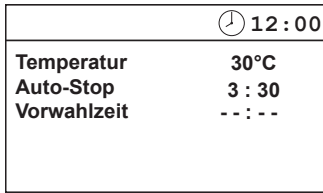

15 s / 🔌 > 3 s

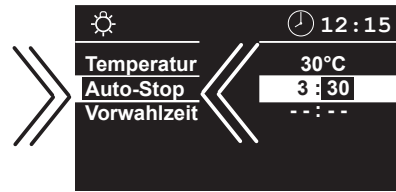

MODE > 3 s

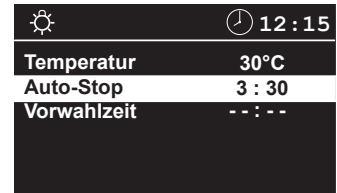

15 s / 🔌

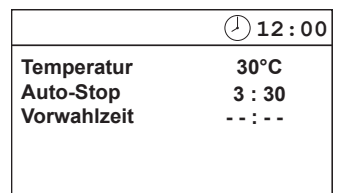
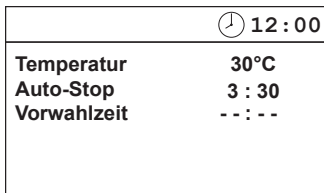

Preselection time

The preselection time is used to pre-select the activation time of your sauna stove within 24 hours.



Always make sure that there are no objects on the sauna unit before the heating process begins. Risk of fire!!

Please remember however that the cabin must heat up for approx. 40-50 minutes in order to achieve a pleasant climate in the cabin. If, for example, you wish to start with your sauna bath at 18:00 hrs, please select 17:10 hrs as your preselection time.

If the sauna system is to be used without a preselection time, "-- : --" must be entered into the display under preselection time. If "00:00" is entered, the sauna will start at 0:00!

In Stand-by

🕒 12:00	
Temperatur	30°C
Auto-Stop	5 : 59
Vorwahlzeit	-- : --

MODE

🕒 12:15	
Temperatur	30°C
Auto-Stop	5 : 59
Vorwahlzeit	-- : --



🕒 12:15	
Temperatur	30°C
Auto-Stop	5 : 59
Vorwahlzeit	-- : --

MODE

🕒 12:15	
Temperatur	30°C
Auto-Stop	5 : 59
Vorwahlzeit	-- : --



🕒 12:15	
Temperatur	30°C
Auto-Stop	5 : 59
Vorwahlzeit	17 : --

MODE

In operation

🕒 12:15	
Temperatur	30°C
Auto-Stop	5 : 59
Vorwahlzeit	-- : --

MODE

🕒 12:15	
Temperatur	30°C
Auto-Stop	5 : 59
Vorwahlzeit	-- : --



🕒 12:15	
Temperatur	30°C
Auto-Stop	5 : 59
Vorwahlzeit	-- : --

MODE

🕒 12:15	
Temperatur	30°C
Auto-Stop	5 : 59
Vorwahlzeit	-- : --



🕒 12:15	
Temperatur	30°C
Auto-Stop	5 : 59
Vorwahlzeit	17 : --

MODE

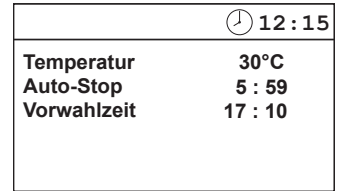
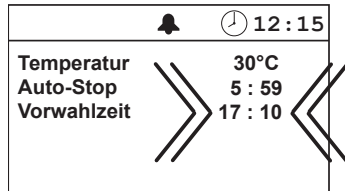
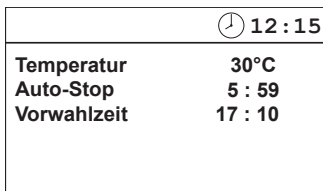
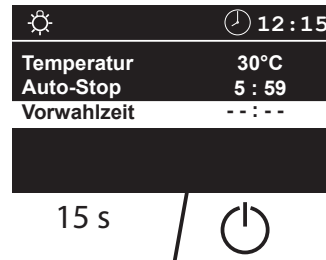
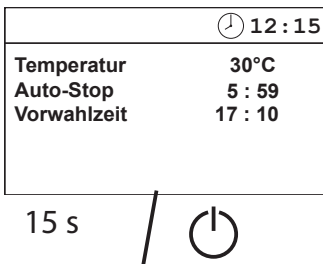
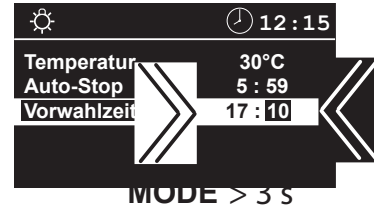
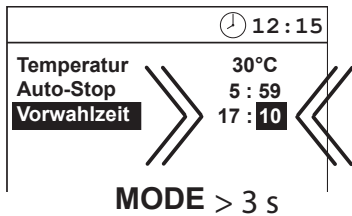
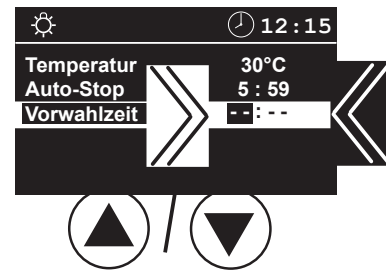
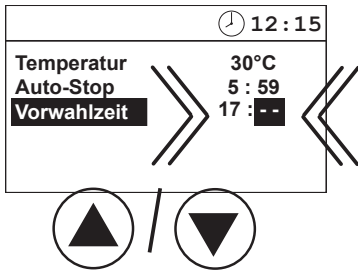

To the preselection time



Deactivate the preselection time

Activate the preselection time

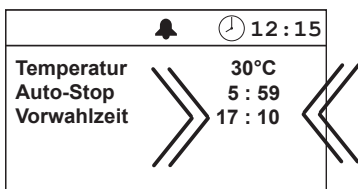

To the preselection time

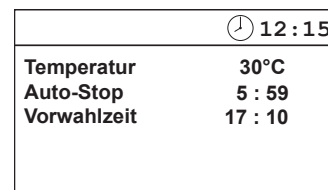
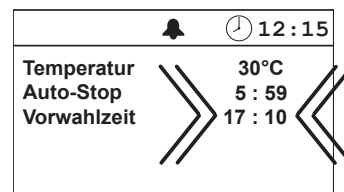

If the sauna system is to be used without a preselection time, "-- : --" must be entered in the display under preselection time.

Life-Guard

Here you can set the time after which the sauna system should be deactivated and reactivated again for the Life-Guard time by pressing the **MODE** button.

This setting can only be made in standby mode if the Life-Guard function is active.

In Stand-by

🕒 12:00	
Temperatur	30°C
Auto-Stop	5 : 59
Vorwahlzeit	--:--
Life - Guard	20 min

MODE

🕒 12:00	
Temperatur	30°C
Auto-Stop	5 : 59
Vorwahlzeit	--:--
Life - Guard	20 min



🕒 12:00	
Temperatur	30°C
Auto-Stop	5 : 59
Vorwahlzeit	--:--
Life - Guard	20 min

MODE

🕒 12:00	
Temperatur	30°C
Auto-Stop	5 : 59
Vorwahlzeit	--:--
Life - Guard	20 min



🕒 12:00	
Temperatur	30°C
Auto-Stop	5 : 59
Vorwahlzeit	--:--
Life - Guard	15 min

MODE

🕒 12:00	
Temperatur	30°C
Auto-Stop	5 : 59
Vorwahlzeit	--:--
Life - Guard	15 min

15 s / 🔌 > 3 s

🕒 12:00	
Temperatur	30°C
Auto-Stop	5 : 59
Vorwahlzeit	--:--
Life - Guard	15 min

🕒 12:15	
Temperatur	30°C
Auto-Stop	5 : 59
Vorwahlzeit	--:--
Life - Guard	14 min



Extend heat-up time restriction / replace device fuse

By altering a jumper you can extend the heat-up restriction from 6:00 (standard) to 12:00 hours or "indefinite". Please note that extensions are only allowed in certain commercially operated sauna systems.

 Only allow a specialist to carry out this work. Before working on the open control unit, disconnect all poles from the mains. (Switch off the master switch, or trigger the FI switch). **Risk of an electrical shock!**

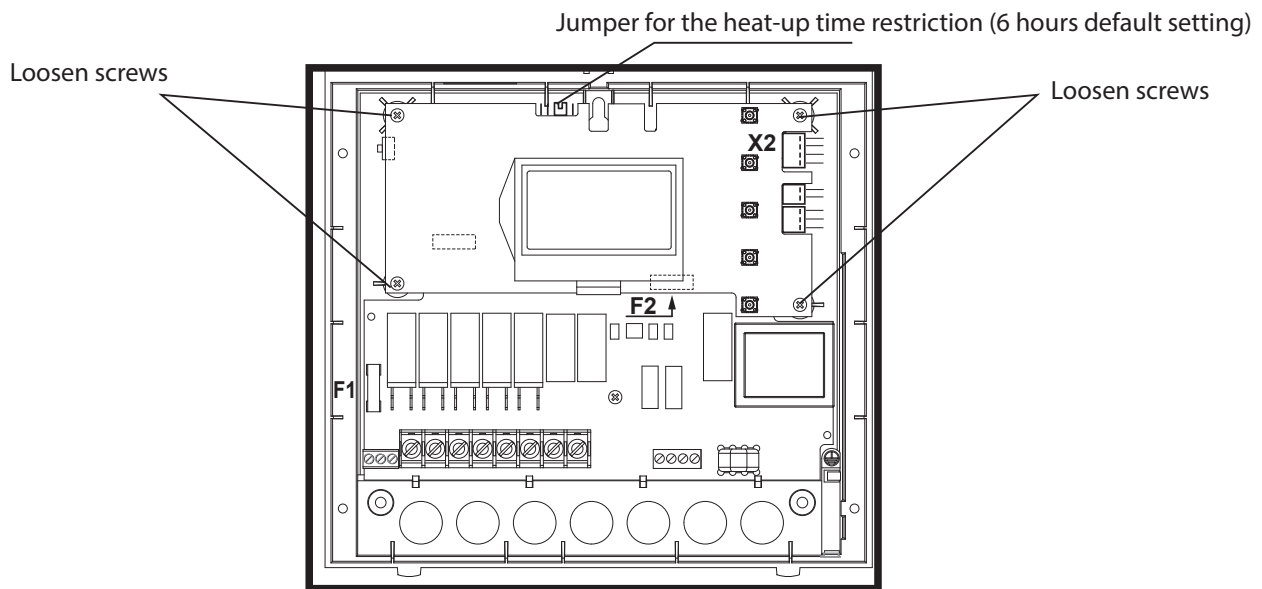
Loosen the four screws on the opened unit that hold the circuit board.



- | | | |
|--------|---|---|
| Jumper |  | 6:00 hours heat-up time restriction (default setting) |
| Jumper |  | 12:00 hours heat-up time restriction |
| Jumper |  | without heat-up time restriction (set auto-stop to - - : - -) |

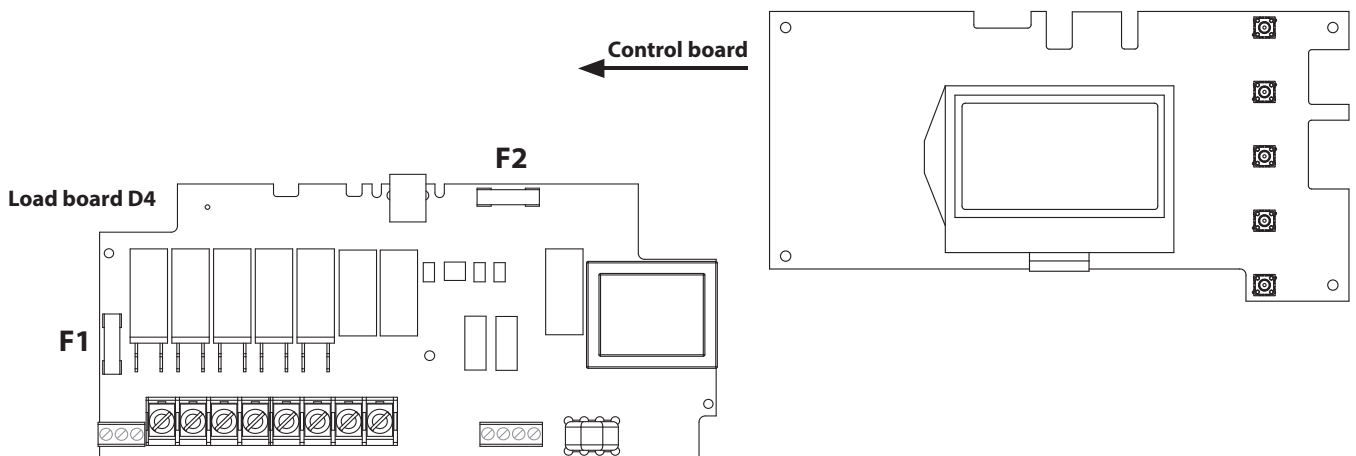

Unit fuses

- | | |
|---------------|--|
| F1 = T 2A | Fuse electronics primary and light and fan |
| F2 = T 315 mA | Fuse of the electronics secondary |

Error messages

The control unit continuously monitors the sensor for short circuits and interruptions. At the same time, the system checks to ensure that there is enough water in the vaporizer tank.

The error messages appear as follows:

Display	Cause	Remedy
<div style="text-align: right;">🕒 12:00</div> <p>Fuehler - bruch</p>	<p>= interrupted room sensor circuit</p> <p>The temperature sensor (PTC) is faulty, or the line to the temperature sensor is interrupted.</p>	<p>Arrange for a specialist to check the lines and PTC. PTC at 20°C approx. 1.9 kΩ ρεπλαχε ιφ νεχεσσαρψ.</p>
<div style="text-align: right;">🕒 12:00</div> <p>Fuehler - schluss</p>	<p>= short-circuit in the room sensor circuit</p> <p>temperature sensor (PTC) is faulty, or the line to the temperature sensor has a short circuit.</p>	<p>Arrange for a specialist to check the lines and PTC.</p>
<div style="text-align: right;">🕒 12:00</div> <p>Thermo - sicherung</p>	<p>= interrupted limiter circuit</p> <p>The temperature fuse (142°C) has triggered or the line to the temperature fuse is interrupted.</p>	<p>Arrange for a specialist to check the lines and temperature fuse.</p>
<div style="text-align: right;">🕒 12:00</div> <p>Bankfühler - bruch</p>	<p>= interrupted bench sensor</p>	<p>Arrange for a specialist to check the lines and PTC. PTC at 20°C approx. 1.9 kΩ ρεπλαχε ιφ νεχεσσαρψ.</p>
<div style="text-align: right;">🕒 12:00</div> <p>Bankfühler - schluss</p>	<p>= short circuit bench sensor</p>	<p>Arrange for a specialist to check the lines and PTC. PTC at 20°C approx. 1.9 kΩ ρεπλαχε ιφ νεχεσσαρψ.</p>

The device „Switch-off“ switch

You will find the rocker switch on the top side of the control unit. You can completely disconnect the control unit from the mains using this switch.

Switch-off by ECON control units

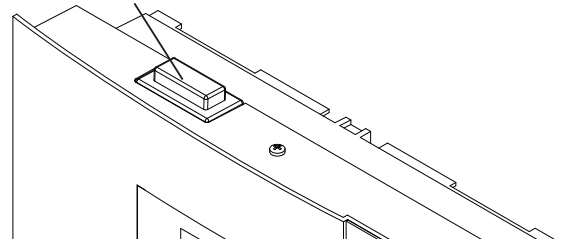

Switch-off

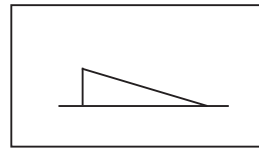

Unit turned on
(default Position I)

Press the switch on the left side of the rocker to the first latch (**switch setting 0**). The switch will be in the middle position. The unit is now completely switched off (disconnected).

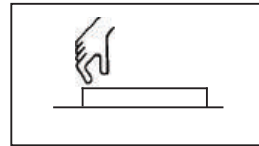

Unit fully switched off
Position 0.

To turn the light on in the cabin while the unit is still disconnected push the left side of the rocker to the second latch (**switch setting II**).

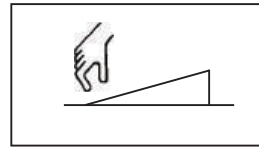

Light switched on;
Unit switched off.
Position II.

To make the unit ready for operation, switch back to the initial position (**switch setting I**). The unit will return to stand-by mode.

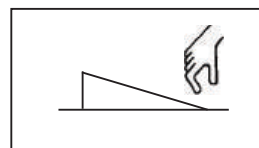





Unit switched on.
Position I.

Manual specification of the lighting:

The control system recognises inductive loads via a voltage rise and then switches from phase control to phase cut-off. If there are recognition problems, the phase control type can be defined manually.



Only a specialist from an authorised specialist company may carry out this work!

1. Disconnect the lighting from the control system
2. Switch the control system on.
3. Go to the menu for setting the light intensity by pressing the  button for >3s
4. Now you can configure the light output:
 - a. Phase cut-off for capacitive and resistive loads: Press **MODE** +  at the same time, display **R,C** in the display
 - b. Phase cut-off for inductive loads: Press **MODE** +  at the same time, display **L** in the display
 - c. Automatic recognition: Press **MODE** +  at the same time, display **R, C / L AUTO** in the display
5. Save the setting by pressing the **MODE** button for >3s
6. Switch the control system off
7. Connect the lighting again



Holiday home mode

The holiday home mode allows the control system to be blocked so that only the most necessary functions are visible and the language for the menu needs to be selected every time before use.

The holiday home mode is activated and deactivated by keeping the Up+Down buttons pressed whilst switching on via Switch-Off. This setting is saved permanently. When the holiday home mode is active, a house symbol is shown at the position of the child lock key.

The control system functions as follows in the holiday home mode:

- * the language is queried every time the control system is activated or when the system returns from the energy-saving mode
- * preselection time, Life-Guard, auto-stop and child lock are not available
- * the settings menu with the time, language, fan setting and Life-Guard cannot be accessed
- * Only the temperature and humidity (only for H4) can be set, and the light activated

Please keep this address in a safe place together with the installation guide.

To help us answer your questions quickly and competently please provide the information printed on the type shield including the model, item no. and serial no., in all inquiries.

Service Address:

EOS Saunatechnik GmbH
Schneiderstriesch 1

35759 Driedorf, Germany

Tel: +49 (0)2775 82-514

Fax: +49 (0)2775 82-431

servicecenter@eos-sauna.de

www.eos-sauna.de

WARRANTY

The warranty is provided according to the legal regulations at present.

Manufacturer's guarantee:

- The period of guarantee starts from the date of purchase and lasts up to 2 years by commercial use and 3 years by private use.
- Always include the completed guarantee certificate when returning equipment.
- The guarantee is void for appliances which have been modified without manufacturer's explicit agreement.
- Damages caused by incorrect operation or handling through non-authorized persons are not covered under the terms of guarantee.
- In the event of a claim please indicate the serial number as well as the item number and model name with detailed description of the fault.
- This guarantee covers defective parts and labour but not the defects caused by wear and tear.

In case of complaint please return the equipment in its original packaging or other suitable packaging (caution: danger of transport damage) to our service department.

Always include the completed warranty certificate when returning equipment.

Possible shipping costs arising from the transport to and from point of repair cannot be overtaken by us.

Outside of Germany please contact your specialist dealer in case of warranty claims. Direct warranty processing with our service department is in this case not possible.

Equipment commissioning date:

Stamp and signature of the authorized electrician:

Handling procedures for return shipments (RMA) - Details for all returns !

Dear customer

we hope that you will be satisfied with the purchased EOS product. In the rear case if you may have a claim and will need to return a product, please follow the procedures specified below. This will enable to ensure a quick and effective handling of the return shipment.

Please observe for all returns!

- Please add the provided **RMA-voucher completely filled out** together with an **invoice copy** to the return shipment! Do not stick it on the goods or on the packaging. **We do not accept return shipments without these papers.**
- Not prepaid parcels **will be refused** and returned to Sender! Please always ask your dealer or EOS service department about the most economical return shipment way.
- **Please pay attention that** the goods have to be sent back in the **original scope of delivery** and in **original packing**.
- We recommend to use an **additional solid and break-proof covering box** which should be padded out with styrofoam, paper or similar. Transport damages as a result of faulty packing are for the sender's account.

Reason of complaint and proceedings:

1) Transportation damage

- Please check the content of your parcel immediately and advise the forwarding company of a claim (parcel service/freight forwarder)
- Do not use damaged goods!
- Ask the forwarder **for a written acknowledgment of the damages.**
- **Report the claim promptly by phone to your dealer.** He will discuss with you how to act in this case.
- If the transport box has been damaged, please use an additional covering box. Do not forget to add the **acknowledgment of the damage of the forwarding company!**

2) Faulty goods

- The implied warranty period is 2 years. Please contact your dealer in case of **faulty or wrong articles or missing accessories.** He will discuss with you the individual case and try for immediate and customer-friendly solution.
- For **economic returns** within Germany you will get an **RMA-number from the manufacturer.**
- All returns have to be in the **original packing of the goods with corresponding accessories.** Please repack the goods to avoid damages. In case of wrong delivery, please do not use this article .

3) Problems of installation and functioning

- Please **read the manual carefully first of all** and pay attention to the indicated assembly or installing instructions.
- **Your dealer should be the first contact person** because he knows his products best and also knows possible problems.
- **In case of function problems with an article,** please check at first whether there is an obvious material defect. The quality system in our factory reduces malfunctions of new appliances to almost zero.