

# ECON H2

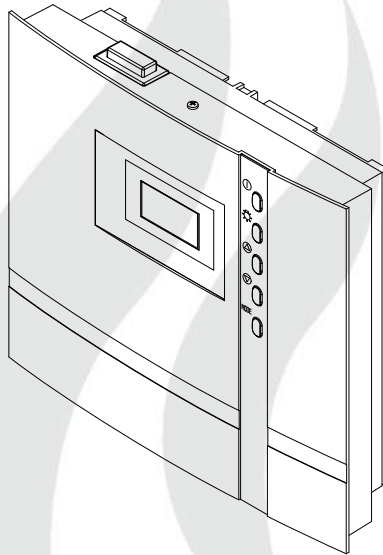

**GB** Assembly and operating instruction

Made in Germany

**CE IP x4**



## Table of Contents

Package contents .....	4
Technical data .....	4
General information concerning sauna bathing .....	5
General safety precautions .....	6
Installation of the control unit .....	7
Wall mount fixture .....	7
Wall mounting .....	7
Wall recessing .....	8
Connecting the sensor cables .....	9
Installation of the heater sensor .....	9
Electrical connection .....	11
Connecting a load switch (LSG) .....	11
Connecting the sauna heater .....	11
Connecting the vaporizer .....	11
Connecting the sauna lamp .....	11
Connecting a fan .....	11
Installation diagram .....	12
Terminal arrangement on the circuit board .....	12
Connecting the sauna heater (max. 9 kW) .....	13
Connection of sauna heater > 9 kW .....	13
Connection of vaporizer .....	14
Operation .....	15
General .....	15
The user interface .....	15
Operating buttons .....	15
Default display Stand-by .....	16
Default display in operation .....	16
Energy-saving display .....	16
Cabin lighting .....	17
Initial commissioning .....	18
Change language .....	19
Change time .....	19
Activating / deactivating the Life - Guard .....	20
Activate / deactivate the child lock .....	20
Switching on the sauna unit .....	21
Switching off the sauna unit in the .....	

Finnish mode .....	21
Switching on the sauna unit with Life - Guard.....	21
Individual settings.....	22
Cabin temperature .....	22
Humidity operation .....	23
Humidity intensity.....	24
Switching off the sauna unit during humidity operation.....	25
Auto-Stop.....	26
Preselection time .....	28
Activate the preselection time .....	29
Deactivate the preselection time.....	29
Life - Guard .....	30
Extend the time setting for sauna time.....	31
Unit fuses .....	31
Error messages.....	32
The device switch (Switch-off) .....	33
Service Address: .....	34
Guarantee .....	34
General Terms and Conditions of Service .....	35

## Package contents

(subject to change)

Included with the control unit are

1. an oven-sensor board with overheat shutoff protection, KTY-sensors with sensor housing, two 3x25 mm fastening screws and a 2,0 m long sensor cable.
2. a plastic bag with three 4 x 20 mm fastening screws.
3. a replacement overheat protection module

## Technical data

Rated voltage:	400 V 3 N 50 Hz AC
Breaking capacity:	max 9 kW resistive load (AC 1 operation) Climatic operation: 6 kW + 3 kW for vaporizer unit, upgrade to 36 kW possible through connection to circuit breakers
Heating time limit:	6 h, 12 h
Display:	Display 65 x 37 mm
Dimensions (HxWxD):	220 x 250 x 67 mm
Protection type:	IPx4 in accordance with EN 60529, Splashproofing
Control range, sauna operation:	30 to 115° C
Control range, steam operation:	30 to 70°
Humidity control:	proportional to time
Sensor system:	KTY sensor with safety temperature limiter 142°C
Water level monitor:	Lack of water results in sauna being switched off after 2 minutes
Type of regulation:	Digital two-point control
Ventilation capacity:	max. 100 W
Light:	max. 100 W
Reheating:	30 mins / 90°C.after humidity programme switches off
Environmental temperature	-10°C bis +40°C
Storage temperatures:	-20°C bis +70°C

Dear customer

You have purchased a high-quality technical device with which you will have years of sauna fun. This sauna control unit was designed and inspected according to the current European safety standards and manufactured at the factory in accordance with the quality management standard DIN EN ISO 9001:2000.

This detailed installation and operation manual has been prepared for your information. Please observe in particular the **important notes** and the information on electrical connection.

We wish you exhilarating recreational experience and lots of fun with your sauna!

## Intended use

This sauna control unit is exclusively intended for the control of the sauna heater in a sauna cabin.

Any other use over and above the intended purpose is not considered as appropriate use! Compliance of the standard operation, maintenance and repair conditions is also an element of appropriate use.

The manufacturer cannot be held liable for deviating, unauthorized alterations and any resulting damages: the initiator of these changes bears the full risk.

## General information

Please check whether the unit has arrived in perfect condition. Any transport damages should be immediately reported to the freight forwarder delivering the goods or you should contact the company that shipped the goods.

Please note that you will only be able to achieve an optimum sauna climate if the cabin with its air intake and ventilation, the sauna heater and the control unit are aligned to each other.



Please observe the information and stipulations made by your sauna supplier.

Sauna heaters heat up your sauna cabin using heated convective air. Here, fresh air is drawn in from the air intake which, when heated, rises upwards (convection) and is then circulated within the cabin. Part of the used air is pushed out through the vent in the cabin. This creates a typical sauna climate which can achieve temperatures of approx. 110°C measured directly under the ceiling of your sauna, dropping in temperature to approx. 30-40°C towards the floor. It is therefore not unusual to measure temperatures of 110°C on the temperature sensor hanging over the heater, whilst the thermometer hanging on the sauna wall, approx. 20-25 cm under the cabin ceiling, only indicates 85°C. The bathing temperature generally lies between 80°C and 90°C in the area of the upper bench when the temperature is set to maximum.

Please note that the highest temperatures are always generated over the sauna heater and that the temperature sensor and the safety limiter must be mounted there in accordance with the control unit installation instructions.

When heating up for the first time, you may notice a slight smell caused by evaporating lubricants used in production processes. Please ventilate your cabin before beginning your sauna bath.

## General safety precautions

- This device can be used by children aged 8 upwards and by persons with physical, sensory, or mental disabilities, or who have inadequate experience and knowledge if they are supervised or if they have received adequate instruction in how to use the device safely and understand the associated risks. Children may not play with this device. Children may not clean or carry out any user maintenance if unsupervised.
- Children are to be supervised in order to make sure that they do not play with this device.
-  **Attention:** It is forbidden to install the control box in a closed switch cabinet or behind a wooden panelling!
- The electrical installation may be done only by a qualified electrical technician.
- You must comply with the regulations of your power supply company and applicable VDE regulations (DIN VDE 0100).
-  **WARNING:** Never attempt repairs or installations yourself, as this could result in serious injury or death. Only a qualified technician may remove the housing cover.
- Please note the dimensions in the assembly instructions, especially when installing the temperature sensor. The temperature above the oven is critical for the temper-

ature setting. The temperature can be held within operating parameters and a minimal temperature gradient inside the bench area of the sauna cabin can be achieved only if unit is assembled correctly.

- The device may only be used as intended as a control unit for sauna ovens up to 9 kW (up to 36 kW when combined with a contactor box).
- Completely disconnect the control unit from the electrical circuit, i.e. flip all circuit breakers or the main circuit breaker during each installation or repair.
- Please note the safety and installation information from the sauna oven manufacturer.
- Always heed the specifications and instructions of the cabin manufacturer, too.
-  **If control units with remote control options\* are used, protection against activation when the heater is covered is required. (e.g. cover protection Type 1-5 or S-Guard).**

*\*Telecontrol = setting up, controlling or adjusting a unit by a command that can be given out of view of the unit by means of transfer media such as telecommunication, audio technology or bus systems. (this also includes weekly timers)*

 When designing the cabin ensure that the external exposed glass surfaces only reach a maximum temperature of 76°C. If necessary, protective features need to be fitted.

 **Attention!**

Dear customer,  
according to the valid regulations, the electrical connection of the sauna heater and the control box has to be carried out through the specialist of an authorized electric shop

We would like to draw your attention that in case of a warranty claim, you are kindly requested to present a copy of the invoice of the executive electric shop.

# Installation of the control unit

## Wall installation

The control unit may only be mounted outside the sauna cabin. It is advisable to select the outside wall of the cabin to which the sauna heater is fixed from the inside as mounting position. If ductwork is already provided for electrical installations then the position of the control unit is predetermined by that. Please follow the instructions for installation:

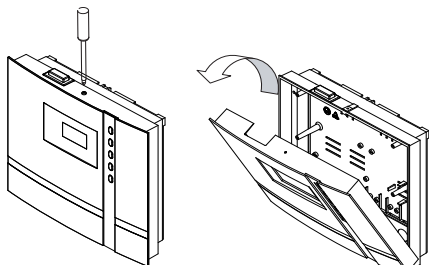

Fig. 1

Remove the control device cover. In order to do this loosen the screw at the top of the housing and pull the housing top upward while swiveling (Fig. 1).

## Surface-mounted installation

1. The 3 mm diameter boreholes for the supplied wood screws 4 x 20 mm are drilled according to the dimensions shown in Fig. 3 + 3.1.
2. Insert one of the wood screws into the top center hole. The control unit is hooked onto this screw. Therefore, leave the screw out by approx. 3 mm (Fig. 3.2).
3. Hook the control unit onto the 3 mm protruding screw in the upper mounting hole. Insert the supplied rubber grommets into the openings at the rear wall of the housing and insert the connecting cable through these openings.

Fasten the housing bottom at the two bottom openings (Fig. 4) firmly to the cabin wall.

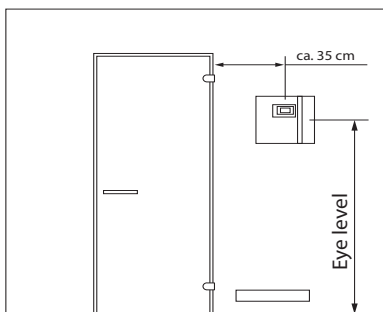

Fig. 3

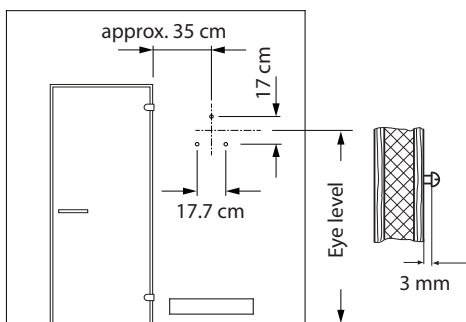

Fig. 3.1

Fig. 3.2

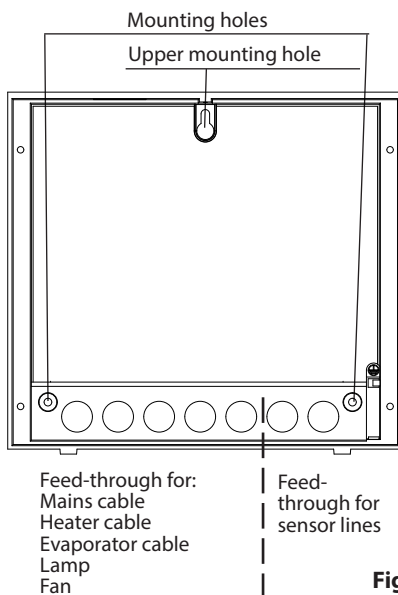

Fig. 4



## Recessed installation

1. Cut out a wall section that is at least 3.5 cm deep according to the dimension in Fig. 5.

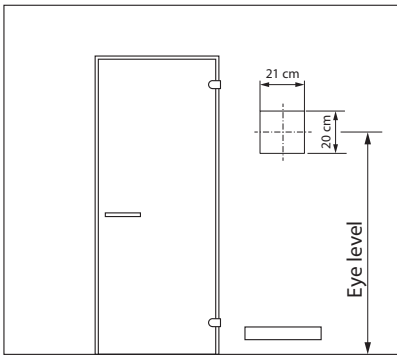

Fig. 5

Insert the supplied rubber grommets into the openings at the rear wall of the housing and insert the connecting cables through these openings.

Place the control unit into the wall opening and fasten it with 4 wood screws.

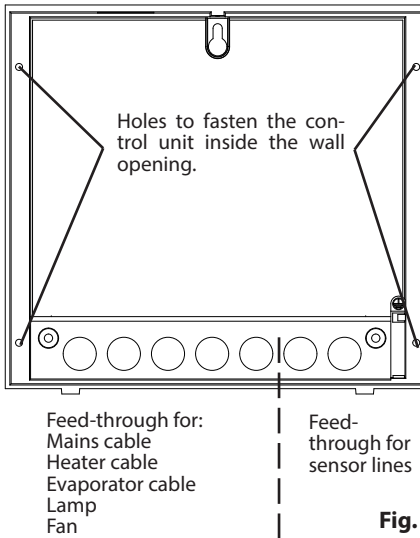

Fig. 6

## Connecting the sensor cables

You should not install sensor and power supply lines together, or lead them through the same feedthrough. This can lead to interferences in the electronics, such as "fluttering" in the relays. If it is necessary to lay the cables down together, or if the line is longer than 3m, use a shielded sensor cable (4 x 0.5 mm<sup>2</sup>).

Connect the shielding to ground in the control unit.

Please observe that the following dimensions relate to the values stipulated during the unit inspection acc. EN 60335-2-53. The heater sensor must always be installed at the point where the highest temperatures are to be expected. Illust. 7-9 give you an overview of the mounting point of the sensor.



## Installation of the heater sensor

1. Mount the oven sensor in cabins up to 2 x 2m according to Illust. 7 and 9, in larger cabins according to Illust. 8 and 9.

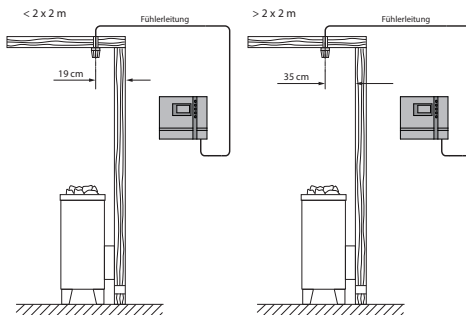

Fig. 7

Fig. 8

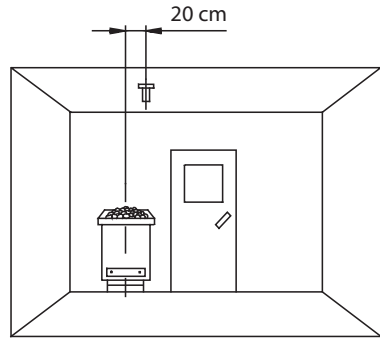
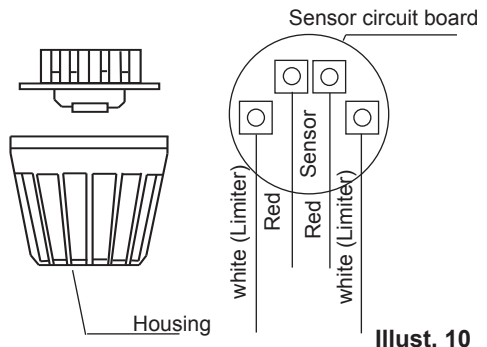

Fig. 9

2. Drill a hole to lead the cable through, preferably through the middle of one of the wooden boards.
3. Lead the sensor cable through the drilled hole and attach it to the sensor line according to Illust. 10.
4. The cables for the limiter (white) and the temperature sensor (red) are connected to the sensor circuit board acc. Fig. 10. Engage the sensor board into the casing.
5. Lead the sensor cables through the right cable intake into the control unit. Install the sensor cables inside the control unit as shown in Fig. 11. Connect the sensor cables as shown in Fig. 12. In order to do this, pull the plug X2 from the circuit board and plug it back in after the connection.



Illust. 10

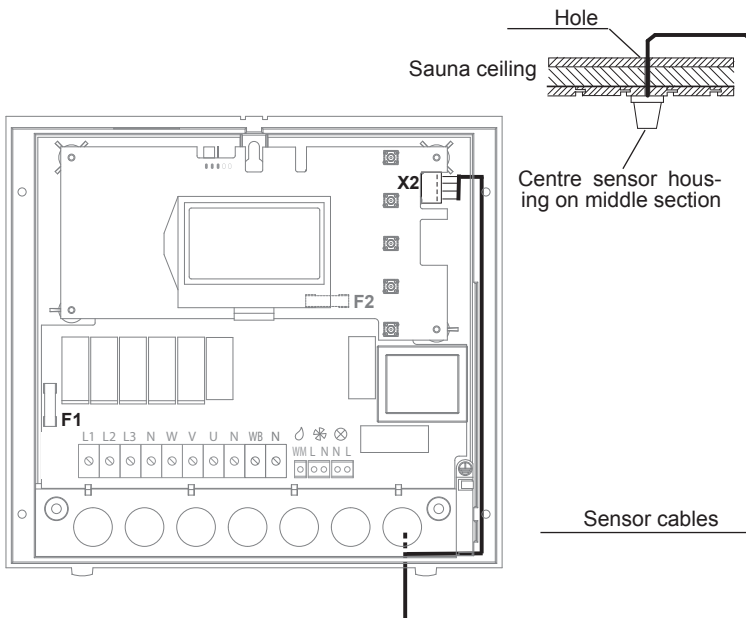

Fig. 11

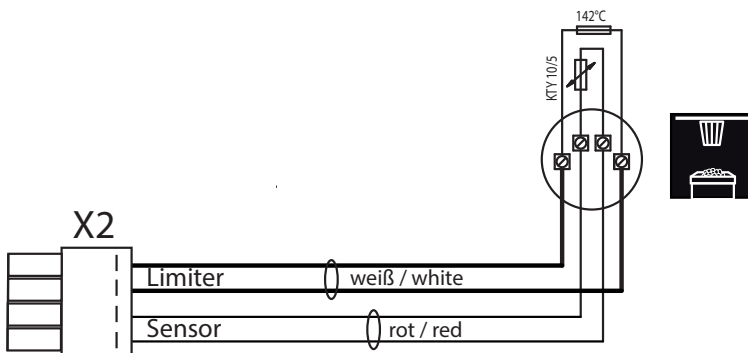

Fig. 12

6. After completed installation and correct operation of the control unit, the line for overtemperature protection must be checked for short-circuits. In order to do this, disconnect one of the white cables in the sensor casing. The respective error message appears in the display.



## Electrical connection

The electrical connection may only be done by a certified electrician in compliance with the guidelines of the local utility company and the VDE.

In general, there may be only one fixed connection to the network; therefore equipment should be provided that makes it possible to disconnect the system with all poles from the network with a contact opening width of minimum 3 mm.

All electrical installations and all connection lines that are installed inside the cabin must be suitable for an ambient temperature of at least 170 °C.

The power supply line is run to the load control unit and connected to the power input terminals.



### Connecting the sauna heater

Install the sauna heater and the vaporizer in front of the air intake according to the manufacturer's installation instructions.

Run the silicone line through the ductwork to the power unit and connect it to the appropriate terminals as directed in the wiring diagram.

**Note:** In case there is no ductwork available drill a hole next to the air intake opening and run the heater line through this hole to the outside and to the appropriate terminals in the control unit. The silicone line must be buried to protect it from outside influences. Therefore, use a suitable cable-duct or a PVC-pipe through which you can run the line up to the power unit.



### Connecting a load switch (LSG)

For details refer to the installation instructions of the LSG.



### Connecting the vaporizer

To connect the vaporizer, use silicone connecting lines 4 x 1,5 mm<sup>2</sup> as well.



**Warning:** When connecting the vaporizer make sure it is correctly attached to the water bath (WB) and low water shutoff (WM). If you switch these connections, you disable the water deficiency function and bypass the thermostat. As a result, the vaporizer will overheat.

**Risk of fire!**

The control unit can detect water deficit if there is a zero-potential feed at the WM-input.



### Connecting the sauna lamp

The sauna lamp must be weatherproof protected (IPx4) and resistant to the ambient temperature. The sauna lamp may be installed at any location but never in the vicinity of the rising hot air of the heater.



### Connecting a fan

The fan must be weatherproof protected (IPx4) and resistant to the ambient temperature.

The fan can be mounted at any point, but never near to rising hot air from the heater and as far as possible from the installation position of the IR lamp (may not be in the direct beam).

# Installation diagram

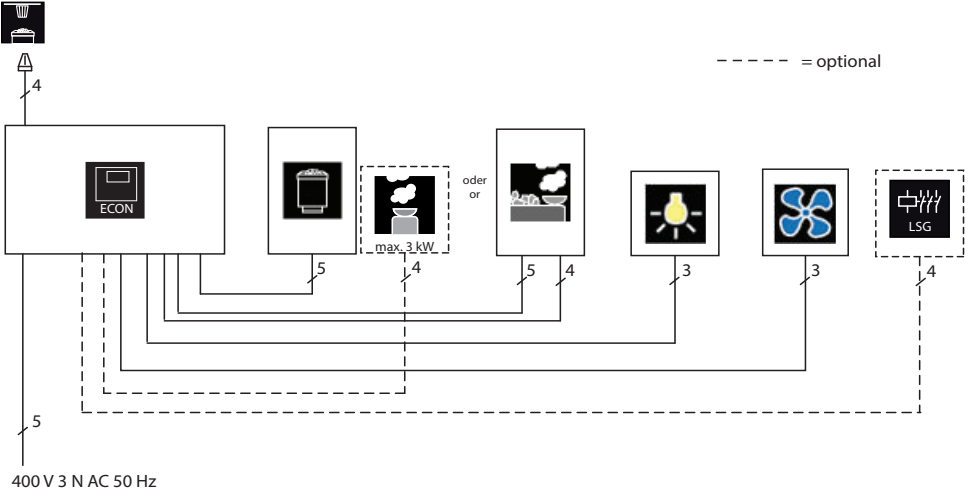

# Terminal arrangement on the circuit board.

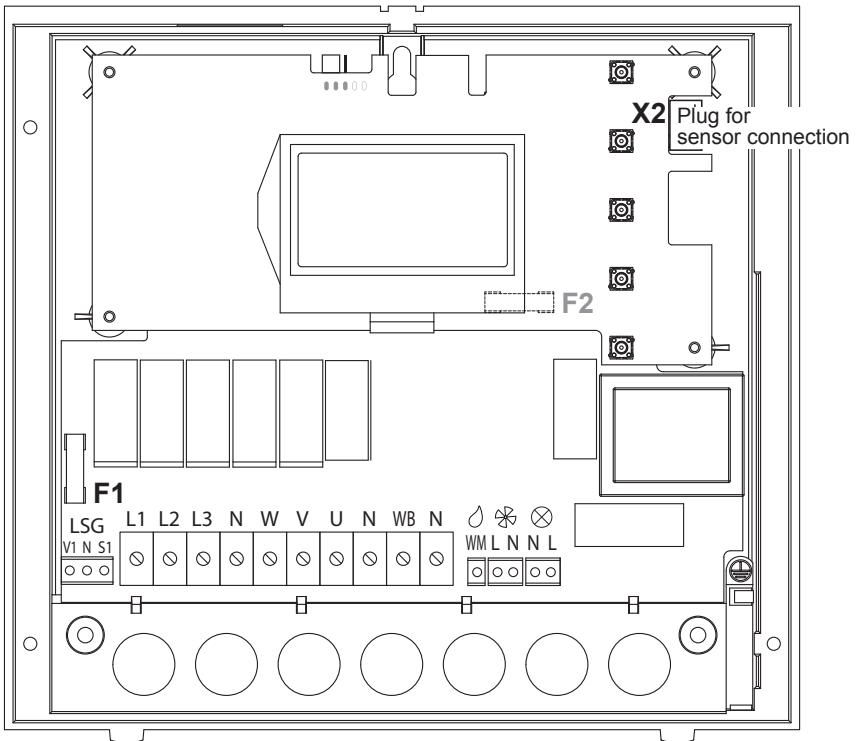

## Connecting the sauna heater (max. 9 kW)

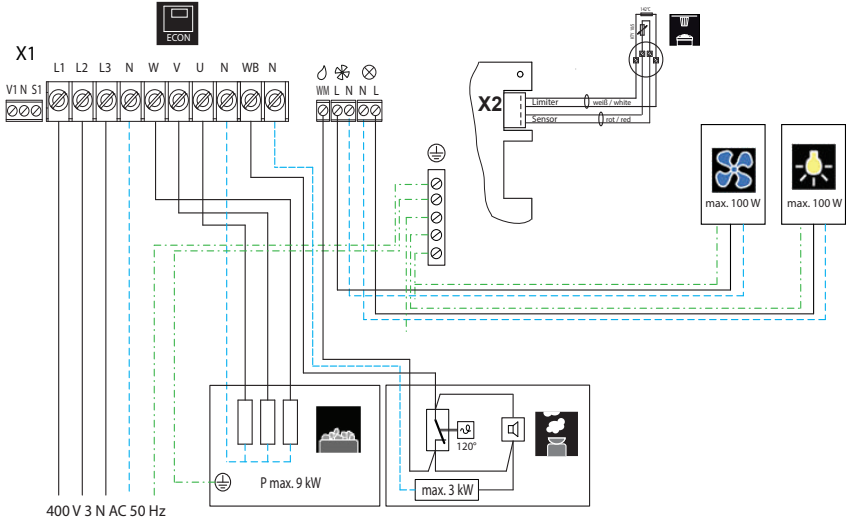

**Warning:** Always connect the neutral conductor of the sauna oven. During steam operation, one phase of the oven is shut down; therefore the heating load is no longer symmetrical. The result is that the neutral wire is no longer current-free.

## Connection of sauna heater > 9 kW

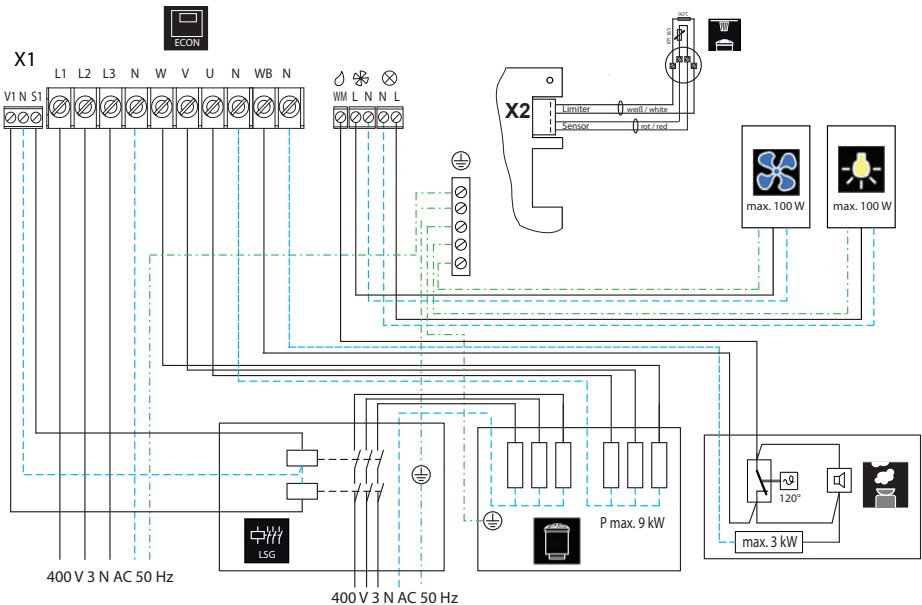

## Connection of vaporizer

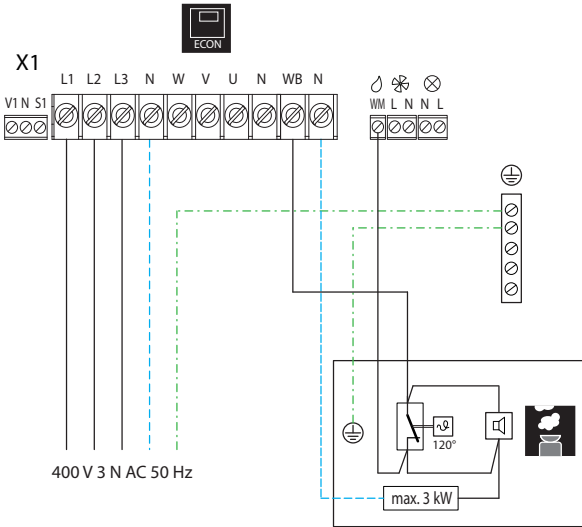

### CAUTION:

When connecting the vaporizer the output “W” is switched from the sauna heater to the terminal “Wb” to the vaporizer.

In this case, the sauna heater heats only with two thirds of the power.

## Operation

Once the system has been installed with all components and all covers have been fixed, you can put your sauna unit into operation.

Over the following pages we will show you the options provided to you with the control.

## General

### The user interface

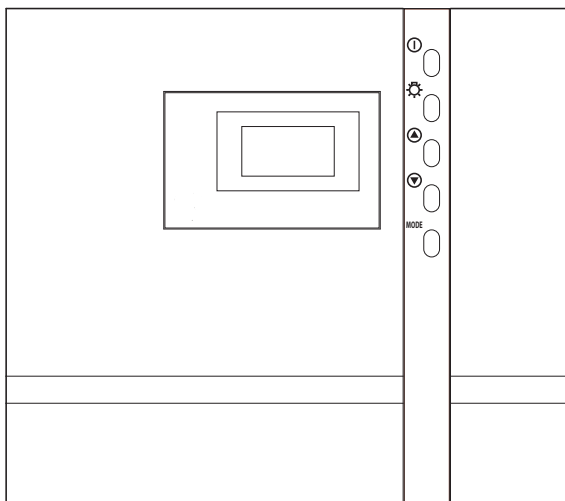

### Operating buttons

 = System On - Off

 = Cabin lighting

**MODE** = Programming mode

 = Increase the value

 = Decrease the value



## Default display Stand-by

is shown if the system is in Stand-by mode.

Reset to this display takes place from other menu items if no activity is carried out > 15 s.

	🕒 12:00
Temperature	30°C
Humidity	▬
Auto-stop	5 : 59
Start time	--:--

## Default display in operation

is shown if the system is in operation.

Reset to this display takes place from other menu items if no activity is carried out > 15 s.

☀️	🕒 12:15
Temperature	30°C 📊
Humidity	▬
Auto-stop	5 : 59
Start time	--:--

Illustration of the heating performance:

During the heating phase the bars behind the temperature display fill continuously.

Once the target temperature is reached, these bars are shown filled



## Energy-saving display

If the unit is not used, it will switch into energy-saving mode. A moving time is shown after 5 minutes, similar to a PC screen-saver. After additional 15 minutes the back light of the display is switched off.

By pushing any key you can return to the default display Stand-by.

The following applies for all settings:

The following is shown in the top area of the display:



The light symbol  
(when the light is switched on)



The clock symbol

12 : 00

Current time

In addition, the following symbols can be displayed depending on the operating mode selected.



Reheat phase  
(after humidity operation)



Child lock active



Preselection time

In order to adjust the individual values to the particular desires, briefly push the **MODE** -button out of Stand-by.

The modifiable parameter will then be highlighted in black and it is possible to select with the ▲ or ▼ - buttons the desired parameter.

Parameters that blink on the display can be changed and are shown in these instructions as displayed.

By pushing the **MODE** -button again you will arrive at the programming level.

The name of the parameter is now blinking and the modifiable value is highlighted in black.

The value highlighted in black can now be changed with the ▲ or ▼ - buttons.

All settings out of Stand-by are confirmed by pressing **MODE** > 3 s and saved in the unit.

The blinking of the parameter ends and the new value is now authoritative until another change is made.

If no key is pressed for > 15 s., the unit switches back into the default display. Changes made up to then are not saved

## Cabin lighting

The cabin lighting automatically is switched on as soon as the sauna unit is switched on. The - Symbol is shown in the top left of ☼ the display. When the sauna unit is switched off, the cabin lighting switches off with a delay of 30 minutes.

Irrespective of the status of the sauna unit, the cabin lighting can be switched on or off anytime ☼ with the button.

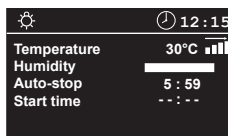
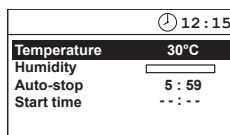
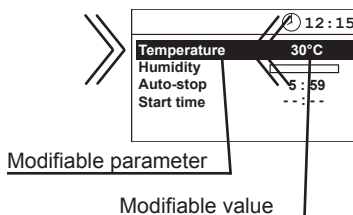
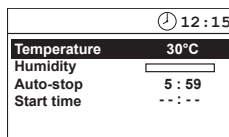

# Initial commissioning

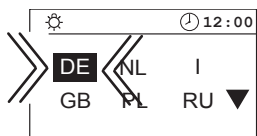

MODE > 3 s



MODE

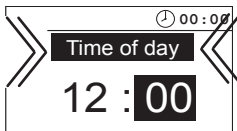

MODE > 3 s

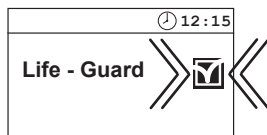
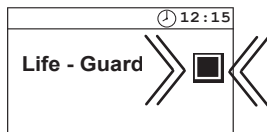

MODE > 3 s

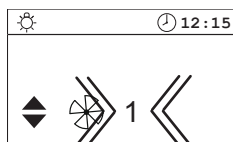
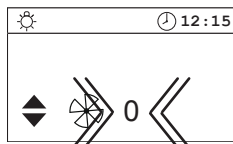
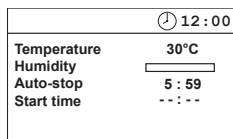

MODE > 3 s

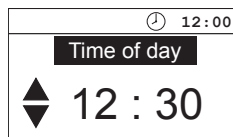

## Change language

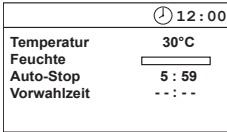

MODE &

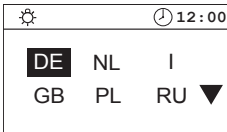

MODE

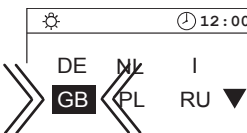
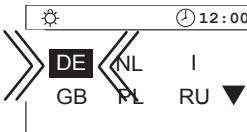

MODE > 3 s



## Change time

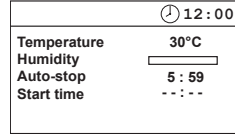

MODE &

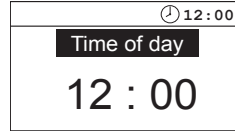

MODE

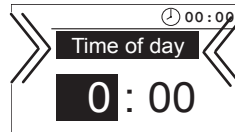

MODE



MODE > 3 s

## Activate / deactivate the Life - Guard

Life - Guard is a settable relatively short time, e.g. 20 minutes, after which the sauna unit is switched off, except for the cabin lighting. After this time has expired the unit can be switched on again by pushing the **MODE** - button for the set time.

### Activate

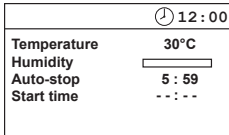

MODE &

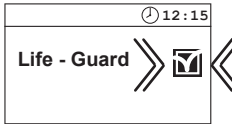
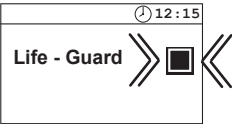

MODE > 3 Sek

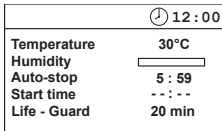

Life Guard activated

### Deactivate

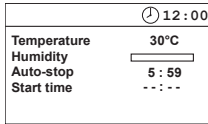

MODE &

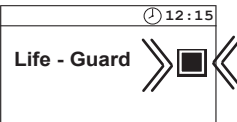
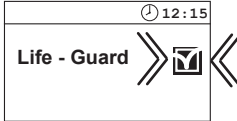

MODE > 3 Sek

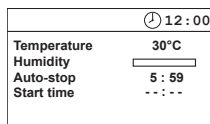

Life Guard deactivated

## Activate / deactivate the child lock

If the child lock is activated (the key symbol is visible in the top section of the display) only the cabin lighting can be switched. All other buttons are without function. The child lock can be activated / deactivated in Stand-by as well as in operation. The unit can still be switched off when in operation.

### Activate

#### Stand-by

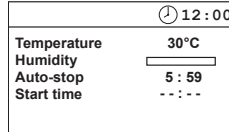

& > 3 s

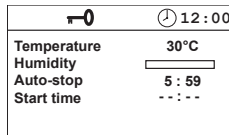

### Deactivate

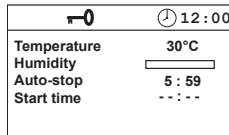

& > 3 s

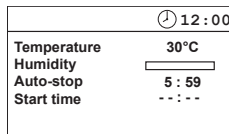

#### Operation

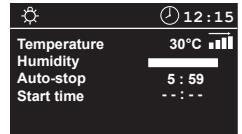
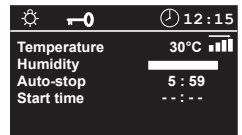
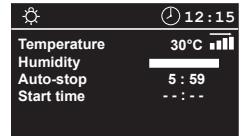

## Switching on the sauna unit

🕒 12:00	
Temperature	30°C
Humidity	▬
Auto-stop	5:59
Start time	--:--

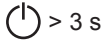

🕒 12:15	
Temperature	30°C 📶
Humidity	▬
Auto-stop	5:59
Start time	--:--

## Switching on the sauna unit with Life - Guard

🕒 12:00	
Temperature	30°C
Humidity	▬
Auto-stop	5:59
Start time	--:--
Life - Guard	20 min



🕒 12:15	
Temperature	30°C 📶
Humidity	▬
Auto-stop	5:59
Start time	--:--
Life - Guard	20 min

The sauna heater will now heat normal, without „Life - Guard „- time. To activate the function „Life - Guard“.

### MODE

🕒 12:15	
Temperature	30°C 📶
Humidity	▬
Auto-stop	5:59
Start time	--:--
Life - Guard	20 min

## Switching off the sauna unit in the Finnish mode

🕒 12:15	
Temperature	30°C 📶
Humidity	▬
Auto-stop	5:59
Start time	--:--

Auto-Stop-Time / 🏠

🕒 12:00	
Temperature	30°C
Humidity	▬
Auto-stop	5:59
Start time	--:--

After the „Life - Guard“ - time has expired, the sauna heater is switched off and the entire display blinks.

🕒 12:15	
Temperature	30°C 📶
Humidity	▬
Auto-stop	5:59
Start time	--:--
Life - Guard	20 min

Restart

### MODE

🕒 12:15	
Temperature	30°C 📶
Humidity	▬
Auto-stop	5:59
Start time	--:--
Life - Guard	20 min

or switch off the system



🕒 12:00	
Temperature	30°C
Humidity	▬
Auto-stop	5:59
Start time	--:--

## Individual settings

Hereafter we are showing you options that allow you to adjust the controls to your individual needs. The various parameters can be changed in Stand-by or in operation and the changes are saved in the unit. Changes made in operation are effective directly.

**Cabin temperature** Setting range: Finnish mode 30 - 115°C  
Humidity mode 30 - 70°C

### In Stand-by

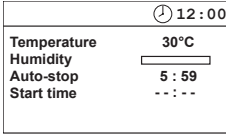

MODE

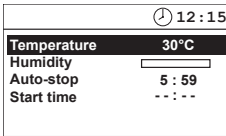

MODE

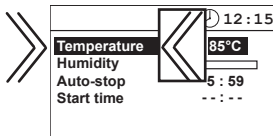
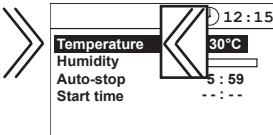

MODE > 3 s

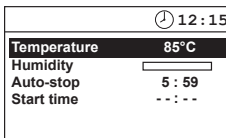

15 s / > 3 s

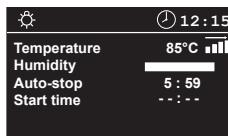
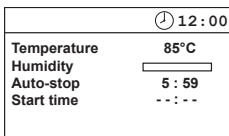

### In operation

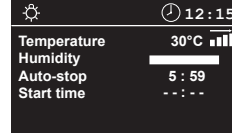

MODE

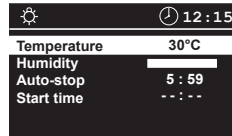

MODE

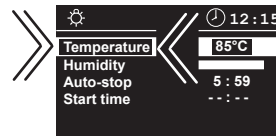
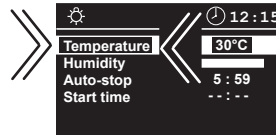

MODE > 3 s

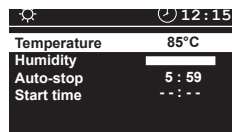

15 s

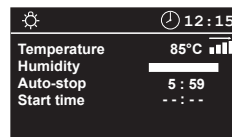

Query of temperature:  
only in the on mode possible



The current temperature is displayed



## Humidity operation

The prerequisite for humidity operation is the connection of a suitable evaporator unit up to max. 3 kW to 230 V AC. The control "clocks" the evaporator, dependent on the set nominal humidity value.

**Note:** Whilst the evaporator is being switched on, the heater only works with 2 phases, meaning that part of the power is switched to the evaporator. On symmetrically wired heaters (same heating output per phase) 1/3 of the heating output of the sauna heater is therefore switched off. This serves on the one hand to protect the user from excessive temperatures, but also to limit the switching capacity to 3.5 kW per phase.

The humidity to be achieved is strongly dependent on the geometry of the sauna cabin, the sauna heater used and the evaporator power. Therefore, you will have to find your own personal climatic zone. Always select the temperature first (from 30 to 70°C) and then the humidity.

Heaters and evaporators which are optimally adapted to the sauna cabins can be used to achieve the humidity values given in the table with a 100% duty cycle.

Temperature	rel. air humidity
60°C	50 %
50°C	60 %
40°C	70 %
30°C	80 %

These achievable values lie higher than the values which are actually required. Therefore, after heating up, please lower them. Please observe that the cabin temperature is highest directly under the cabin ceiling, whereas the relative air humidity is low. The relative air humidity increases as the tem-

perature sinks towards the cabin floor.

The following diagram shows you the relative air humidity temperature values for the standard bath forms and comfort zones.

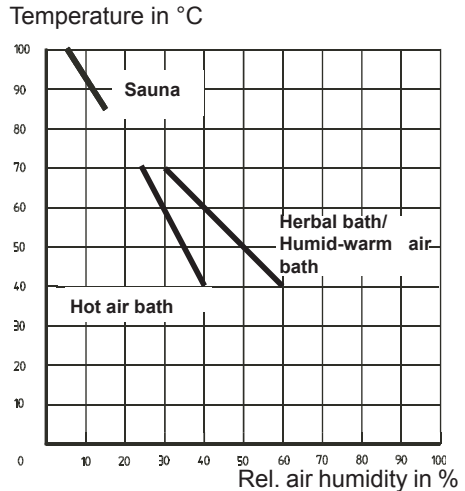

The humidity intensity shown in the display corresponds to the time proportional evaporator setting. Therefore, the relative air humidity is not preselected or shown on the display, but rather the switch-on frequency of the evaporator in percent. The graphic is intended to clarify this.

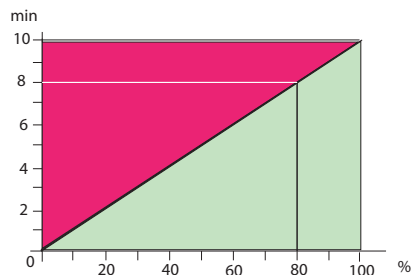

The evaporator is always activated if a value is displayed in the field „Humidity“. Please also observe that the evaporator does not switch on until the temperature has dropped to this value.



## Humidity intensity

If a value is entered here the sauna unit automatically goes into humidity operation when switched on.

### In Stand-by

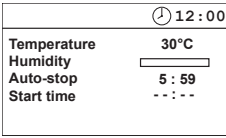

MODE

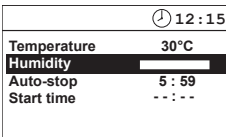
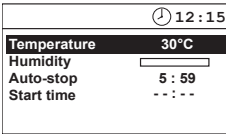

MODE

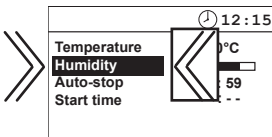
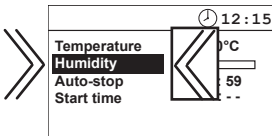

MODE > 3 s

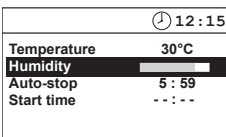

15 s / > 3 s

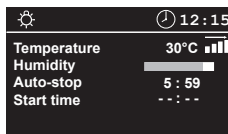
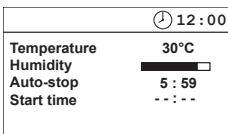

### In operation

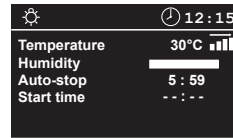

MODE

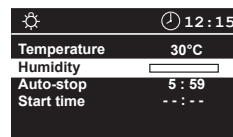
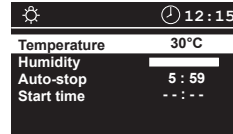

MODE

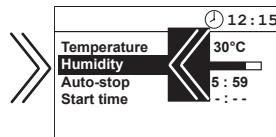
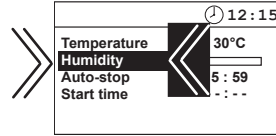

MODE > 3 s

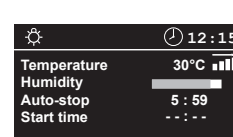

15 s

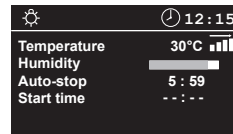



## Switching off the sauna unit during humidity operation

In order to dry out the sauna cabin after the humidity operation, a reheating phase is activated after the humidity operation is switched off. The cabin is heated here to 90°C for ca. 30 minutes. This is shown in the upper section of the display with the blinking symbol . In addition, an optionally installed fan is switched on for the duration of the reheating phase.

The sauna unit automatically turns off once this time has expired.

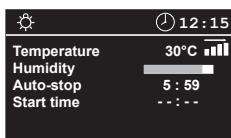
If you wish to interrupt the reheating phase beforehand, push the  -button again.



Auto-Stop. / 

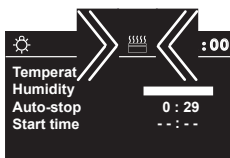

Auto-Stop. / 

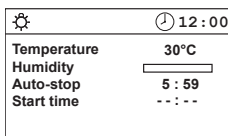

## Auto-Stop

Auto-Stop is the time to which the heating time is limited. The sauna unit automatically turns off once this time has expired.

Depending on the configuration of the control, the time is adjustable from 0:01 to 6:00 or 12:00 hours.

### In Stand-by

🕒 12:00	
Temperature	30°C
Humidity	<input type="text"/>
Auto-stop	5 : 59
Start time	-- : --

MODE

🕒 12:15	
Temperature	30°C
Humidity	<input type="text"/>
Auto-stop	5 : 59
Start time	-- : --



🕒 12:15	
Temperature	30°C
Humidity	<input type="text"/>
Auto-stop	5 : 59
Start time	-- : --

MODE

🕒 12:15	
Temperature	30°C
Humidity	<input type="text"/>
Auto-stop	5 : 59
Start time	-- : --



🕒 12:15	
Temperature	30°C
Humidity	<input type="text"/>
Auto-stop	3 : 59
Start time	-- : --

MODE

🕒 12:15	
Temperature	30°C
Humidity	<input type="text"/>
Auto-stop	3 : 59
Start time	-- : --



### In operation

🕒 12:15	
Temperature	30°C
Humidity	<input type="text"/>
Auto-stop	5 : 59
Start time	-- : --

MODE

🕒 12:15	
Temperature	30°C
Humidity	<input type="text"/>
Auto-stop	5 : 59
Start time	-- : --



🕒 12:15	
Temperature	30°C
Humidity	<input type="text"/>
Auto-stop	5 : 59
Start time	-- : --

MODE

🕒 12:15	
Temperature	30°C
Humidity	<input type="text"/>
Auto-stop	5 : 59
Start time	-- : --



🕒 12:15	
Temperature	30°C
Humidity	<input type="text"/>
Auto-stop	3 : 59
Start time	-- : --

MODE

🕒 12:15	
Temperature	30°C
Humidity	<input type="text"/>
Auto-stop	3 : 59
Start time	-- : --



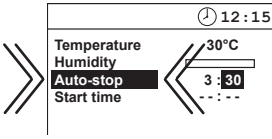

MODE > 3 s

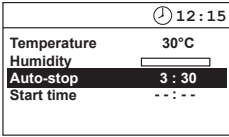

15 s / > 3 s

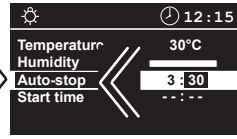

MODE > 3 s

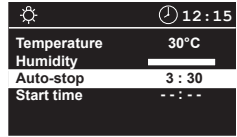

15 s /

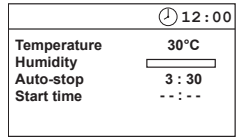
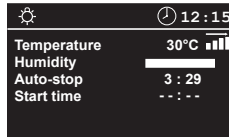
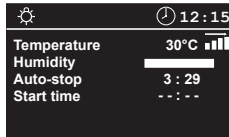
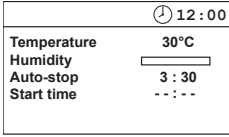

## Preselection time

Using the time preselection, you can preselect a switch-on time within 24 hours for your sauna heater.



**Always make sure that there are no objects on the sauna unit before the heating process begins. Fire risk!**

Please remember however that the cabin must heat up for approx. 40-50 minutes in order to achieve a pleasant climate in the cabin. If, for example, you wish to start with your sauna bath at 18:00 hrs, please select 17:10 hrs as your preselection time.

If the sauna unit is to be used without preselection time, -- : -- must be entered in the display under preselection time.

## In Stand-by

	🕒 12:00
Temperature	30°C
Humidity	▬
Auto-stop	5:59
Start time	--:--

MODE

	🕒 12:15
Temperature	30°C
Humidity	▬
Auto-stop	5:59
Start time	--:--



	🕒 12:15
Temperature	30°C
Humidity	▬
Auto-stop	5:59
Start time	--:--

MODE

	🕒 12:15
Temperature	30°C
Humidity	▬
Auto-stop	5:59
Start time	--:--



	🕒 12:15
Temperature	30°C
Humidity	▬
Auto-stop	5:59
Start time	17:--

MODE

## In operation

	🕒 12:15
Temperature	30°C
Humidity	▬
Auto-stop	5:59
Start time	--:--

MODE

	🕒 12:15
Temperature	30°C
Humidity	▬
Auto-stop	5:59
Start time	--:--



	🕒 12:15
Temperature	30°C
Humidity	▬
Auto-stop	5:59
Start time	--:--

MODE

	🕒 12:15
Temperature	30°C
Humidity	▬
Auto-stop	5:59
Start time	--:--



	🕒 12:15
Temperature	30°C
Humidity	▬
Auto-stop	5:59
Start time	17:--

MODE

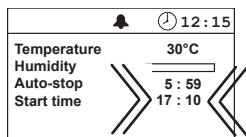
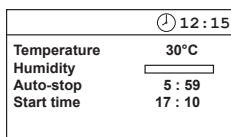
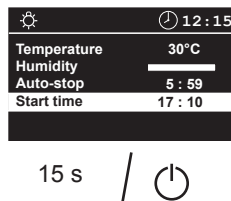
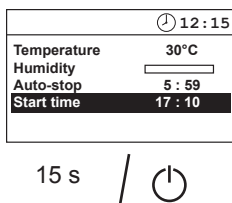
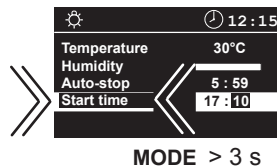
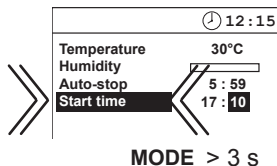
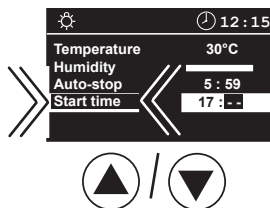
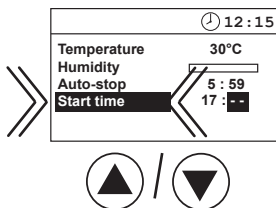

To the preselection time

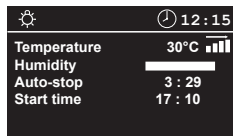
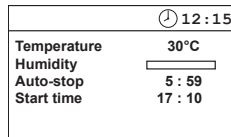
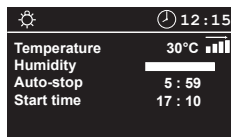

Deactivate the preselection time

Activate the preselection time

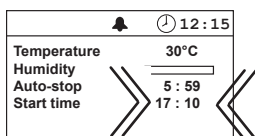

To the preselection time

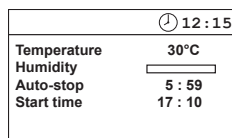
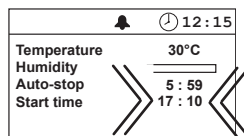
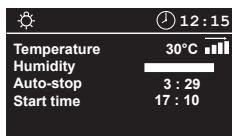

If the sauna unit is to be used without preselection time, -- : -- must be entered in the display under preselection time.

## Life - Guard

Here you can set after what time the sauna unit is switched off and by pushing the **MODE** - button again you can restart the „Life - Guard“ time.

This setting can only be selected in Stand-by when the function „**Life - Guard**“ is activated.

## In Stand-by

🕒 12:00	
Temperature	30°C
Humidity	<div style="width: 50%; border-bottom: 1px solid black;"></div>
Auto-stop	5 : 59
Start time	-- : --
Life - Guard	20 min

**MODE**

🕒 12:00	
Temperature	30°C
Humidity	<div style="width: 50%; border-bottom: 1px solid black;"></div>
Auto-stop	5 : 59
Start time	-- : --
Life - Guard	15 min

15 s / 🔌 > 3 s

🕒 12:00	
Temperature	30°C
Humidity	<div style="width: 50%; border-bottom: 1px solid black;"></div>
Auto-stop	5 : 59
Start time	-- : --
Life - Guard	20 min



🕒 12:00	
Temperature	30°C
Humidity	<div style="width: 50%; border-bottom: 1px solid black;"></div>
Auto-stop	5 : 59
Start time	-- : --
Life - Guard	15 min

⚙️ 🕒 12:15	
Temperature	30°C <span style="font-size: small;">📶</span>
Humidity	<div style="width: 50%; border-bottom: 1px solid black;"></div>
Auto-stop	5 : 59
Start time	-- : --
Life - Guard	15 min

🕒 12:00	
Temperature	30°C
Humidity	<div style="width: 50%; border-bottom: 1px solid black;"></div>
Auto-stop	5 : 59
Start time	-- : --
Life - Guard	20 min

**MODE**

🕒 12:00	
Temperature	30°C
Humidity	<div style="width: 50%; border-bottom: 1px solid black;"></div>
Auto-stop	5 : 59
Start time	-- : --
Life - Guard	20 min



🕒 12:00	
Temperature	30°C
Humidity	<div style="width: 50%; border-bottom: 1px solid black;"></div>
Auto-stop	5 : 59
Start time	-- : --
Life - Guard	15 min

**MODE**

## Extend heat-up time restriction / replace device fuse

By altering a jumper you can extend the heat-up restriction from 6:00 (standard) to 12:00 hours or "indefinite". Please note that extensions are only allowed in certain commercially operated sauna systems.



Only allow a specialist to carry out this work. Before working on the open control unit, disconnect all poles from the mains. (Switch off the master switch, or trigger the FI switch). **Risk of an electrical shock!**

Loosen the four screws on the opened unit that hold the circuit board.

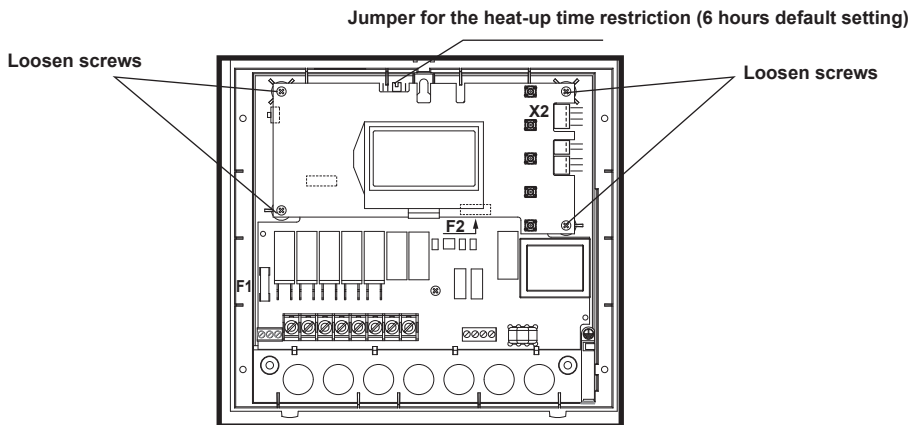

Jumper 6:00 hours heat-up time restriction (default setting)

Jumper 12:00 hours heat-up time restriction

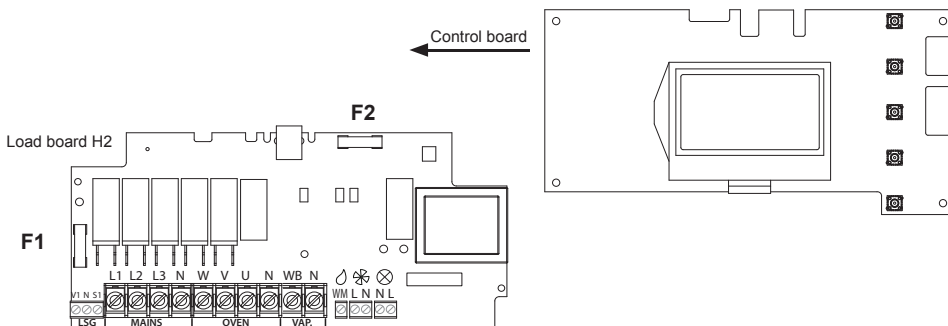

### Unit fuses

F1 = T 2A Fuse electronics primary and light and fan





F2 = T 315 mA Fuse of the electronics secondary



## Error messages

The control unit continuously monitors the sensor for short circuits and interruptions. At the same time, the system checks to ensure that there is enough water in the vaporizer tank.

The error messages appear as follows:

Display	Cause	Remedy
 12:00 <b>Sensor - break</b>	<p>= <b>interrupted room sensor circuit</b></p> <p>The temperature sensor (PTC) is faulty, or the line to the temperature sensor is interrupted.</p>	<p>Arrange for a specialist to check the lines and PTC. PTC at 20°C approx. 1.9 kW replace if necessary.</p>
 12:00 <b>Sensor short -circuit</b>	<p>= <b>short-circuit in the room sensor circuit</b></p> <p>temperature sensor (PTC) is faulty, or the line to the temperature sensor has a short circuit.</p>	<p>Arrange for a specialist to check the lines and PTC.</p>
 12:00 <b>Thermal fuse</b>	<p>= <b>interrupted limiter circuit</b></p> <p>The temperature fuse (142°C) has triggered or the line to the temperature fuse is interrupted.</p>	<p>Arrange for a specialist to check the lines and temperature fuse.</p>
 12:00 <b>humidity sensor-circuit</b>	<p>= <b>short circuit in the humidity sensor circuit</b></p>	<p>Arrange for a specialist to check the lines and sensors.</p>
 12:00 <b>Water shortage</b>	<p>= <b>lack of water</b></p> <p>There is no more water in the vaporizer tank</p>	<p>Refill water.</p>



**Caution, there are hot parts in the tank. Large quantities of steam may be created when filling the tank with cold water. Risk of scalding!**

If no water is refilled, the system will completely switch off after 2 minutes. To restart the system, it first needs to be switched off via the  button, the vaporizer tank needs to be filled and then the system should be started as usual.

# The device „Switch-off“ switch

You will find the rocker switch on the top side of the control unit. You can completely disconnect the control unit from the mains using this switch.

Switch-off by ECON control units

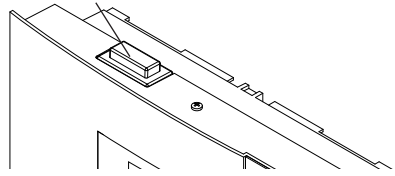

## Switch-off

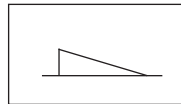

Unit turned on  
(default Position I)

Press the switch on the left side of the rocker to the first latch (**switch setting 0**). The switch will be in the middle position. The unit is now completely switched off (disconnected).

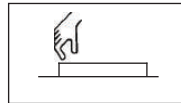

Unit fully switched off  
Position 0.

To turn the light on in the cabin while the unit is still disconnected push the left side of the rocker to the second latch (**switch setting II**).

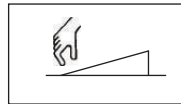

Light switched on;  
Unit switched off.  
Position II.

To make the unit ready for operation, switch back to the initial position (**switch setting I**). The unit will return to stand-by mode.

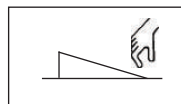

Unit switched on.  
Position I.

Please keep this address in a safe place together with the installation guide.

To help us answer your questions quickly and competently please provide the information printed on the type shield including the model, item no. and serial no., in all inquiries.

## Service Address:

EOS Saunatechnik GmbH  
Schneiderstriesch 1

35759 Driedorf, Germany

Tel: +49 (0)2775 82-514

Fax: +49 (0)2775 82-431

servicecenter@eos-sauna.de

www.eos-sauna.de

## WARRANTY

The warranty is provided according to the legal regulations at present.

### Manufacturer's guarantee:

- The period of guarantee starts from the date of purchase and lasts up to 2 years by commercial use and 3 years by private use.
- Always include the completed guarantee certificate when returning equipment.
- The guarantee is void for appliances which have been modified without manufacturer's explicit agreement.
- Damages caused by incorrect operation or handling through non-authorized persons are not covered under the terms of guarantee.
- In the event of a claim please indicate the serial number as well as the item number and model name with detailed description of the fault.
- This guarantee covers defective parts and labour but not the defects caused by wear and tear.

In case of complaint please return the equipment in its original packaging or other suitable packaging (caution: danger of transport damage) to our service department.

Always include the completed warranty certificate when returning equipment.

Possible shipping costs arising from the transport to and from point of repair cannot be overtaken by us.

Outside of Germany please contact your specialist dealer in case of warranty claims. Direct warranty processing with our service department is in this case not possible.

**Equipment commissioning date:**

**Stamp and signature of the authorized electrician:**

# **General Terms and Conditions of Service**

## **I. Scope**

Unless otherwise agreed in writing in a specific case, these terms and conditions of service shall apply to service operations, including examining and repairing complaints. All our existing or future legal relationships shall be governed solely by the following terms and conditions of service. Our recognition of any conflicting terms and conditions of the Ordering Party shall be conditional upon our having given our express written consent to their applicability. We hereby expressly object to any terms and conditions of the Ordering Party contained in its General Terms and Conditions of Business or order confirmation. If order confirmations or deliveries are accepted without reservation, this shall not be deemed to constitute recognition of such terms and conditions. Any ancillary agreements or amendments must be confirmed in writing.

## **II. Prices and Payment Terms**

The Ordering Party shall bear the following costs in connection with the service operation:

- Disassembly/assembly and electrical (de-) installation
- Transportation, postage and packaging
- Function testing and troubleshooting including inspection and repair costs

There shall be no third-party billing.

## **III. Performance Obligations / Ordering Party's Cooperation**

The Ordering Party shall provide free-of-charge assistance to the manufacturer in carrying out the service operation.

In the case of a warranty claim, the manufacturer shall make the replacement parts necessary for the service available to the Ordering Party free of charge.

## **IV. Service Visit by the manufacturer**

In the event that it is essential that a manufacturer employee carry out the service operation on site, this must be agreed in advance. Where the main reason for the service call is not the fault of the manufacturer, any costs incurred shall be recharged to the Ordering Party after the service visit.

## **V. Liability**

The manufacturer shall assume liability in accordance with the currently applicable statutory regulations. The packaging for all of our products is designed for the shipping of individually packed goods (pallet). We expressly point out that our packaging is not suitable for individual

shipments via parcel post. The manufacturer shall accept no liability for damage incurred as a result of improper packaging in an individual shipment.

## **VI. Manufacturer's Warranty**

The manufacturer's warranty shall apply only in the event that installation, operation and maintenance have been carried out in accordance with the manufacturer's specifications contained in the assembly instructions and instructions for use.

- The warranty period shall commence from the date on which proof of purchase is provided and shall be limited, in principle, to 24 months.
- Warranty services shall be performed only if the proof of purchase relating to the equipment can be presented.
- Any and all warranty claims shall become void if modifications are made to the equipment without the manufacturer's express consent.
- Any warranty claim shall likewise become void in the case of defects that arise due to repairs or interventions made by unauthorized persons or due to improper use.
- In the case of warranty claims, the serial and article numbers must be indicated together with the designation and a meaningful description of the fault.
- This warranty shall cover defective equipment parts, with the exception of normal wear parts. Wear parts shall include, among other things, light sources, starters, gas or oil pressure dampers as well as acrylic glass panes, tubular heating elements and sauna heater stones.
- Only original replacement parts may be used within the warranty.
- Service visits by outside companies shall require a written order to be issued by our service department.
- The equipment in question shall be sent to our service department by the Ordering Party and at its expense.
- Electrical assembly and installation work, including in the event of service or replacement, shall be carried out at the Customer's expense and shall not be borne by the manufacturer.

Complaints in respect of our products shall be reported to the specialist trader responsible and shall be exclusively handled via the latter.

The manufacturer's General Terms and Conditions of Business, as amended, shall apply in addition to the foregoing terms and conditions of service.